







MP Reconstruction System

Uncemented & Cemented

Surgical Technique

CE 0482

Explanation of Pictograms			
	Manufacturer		Article number
	Material number		Product meets the applicable requirements, which are regulated in the EU harmonization legislation for the affixing of the CE marking.

MP Reconstruction System

Uncemented & Cemented

System Description

- 02 System Overview

Surgical Technique

- 03 Preoperative Planning

Surgical Technique, uncemented

- 05 Reaming of the Medullary Canal
- 06 Insertion of the Hip Prosthesis Stem
- 08 Preparation of the proximal femur
- 09 Trial Reduction
- 10 Leg Length and Lateralization, Anteversion, Trial Fixation Screws, Use of a Longer Trial Neck Segment
- 11 Final Assembly
- 13 Stem Extraction

Surgical Technique, cemented

- 14 Procedure

Implants

- 17 Hip Prosthesis Stems, uncemented
- 18 Modular Revision Stems, cemented
- 19 Neck Segments
- 20 Proximal Spacers and Expansion Bolts

Instruments

- 21 Complete Instrument Set
- 22 Instrument Trays 1-10
- 28 Additional Instrument Set, cemented

Accessories

- 29 Additional Instruments, X-ray Templates, Cleaning and Care Instructions

Literature

- 31 Reprints
- 32 Additional Information

- 33 **Indications / Contraindications**

Important Information

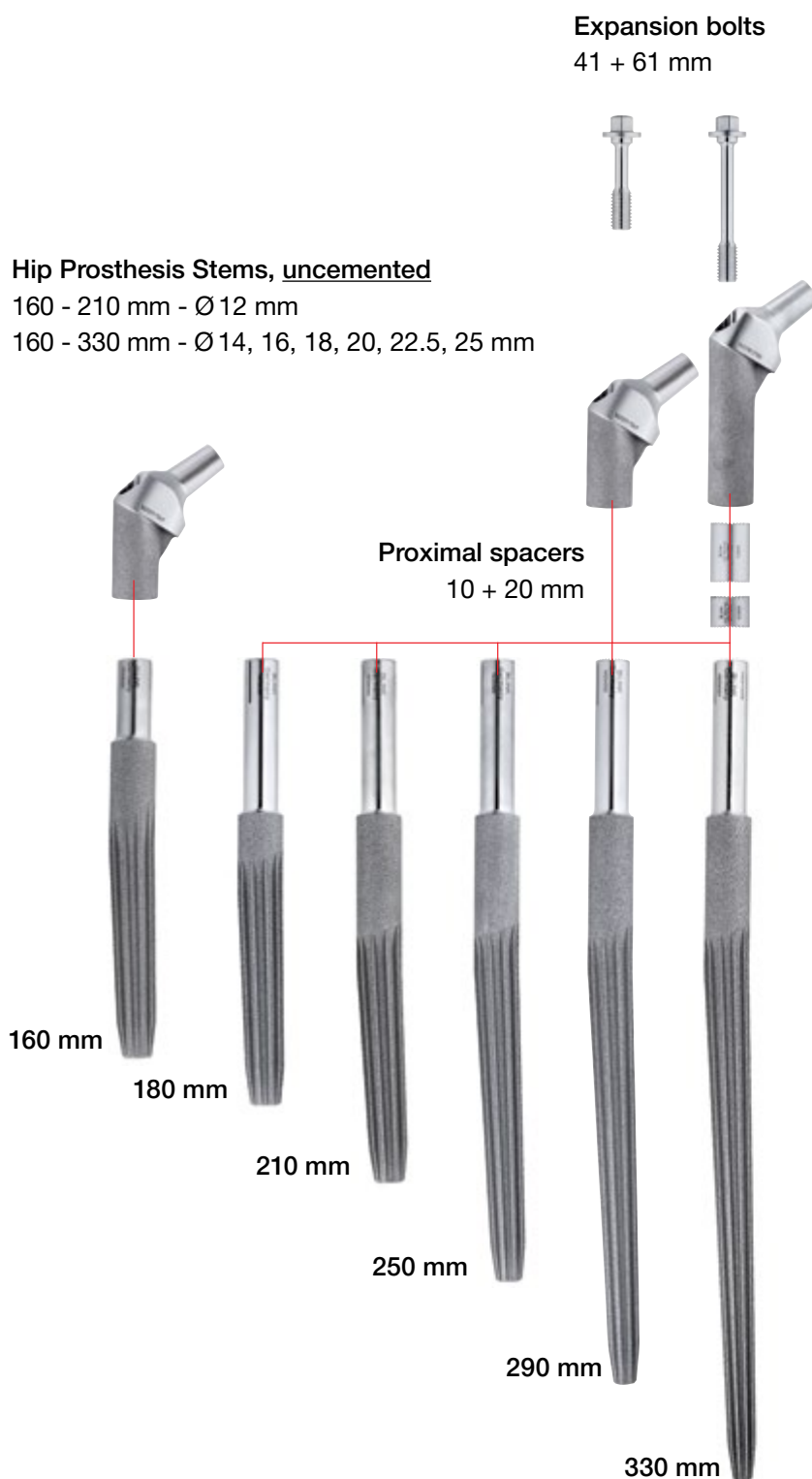

Neck segments

SStandard + XXL
35 + 65 mm, CCD 126° and 135°

with suture holes
Standard and XXL
35 + 65 mm, CCD 126°

35 mm neck segments must only be used without proximal spacers

Modular Revision Stems, cemented
Material: CoCrMo alloy

200 mm
240 mm
280 mm
320 mm

INFORMATION:
160 mm stems must only be used with 35 mm neck segment and without proximal spacers.

Preoperative Planning



It is important to plan the intervention preoperatively in order to select the correct implant type and size and its final intraosseous position based on the patient's individual anatomy. The surgeon should perform a careful evaluation of the patient's clinical condition and consider the level of physical activity before performing a hip replacement. For optimal results, the surgery should be planned in advance using the appropriate templates. The magnification factor of the X-rays must be compatible with the factor on the templates. Special MP Reconstruction System X-ray templates are available in standard 1.1:1.

The implant size must be chosen from adequate AP and ML X-rays with sufficient quality. Each X-ray should be large enough for application of the whole template. A second X-ray of the unaffected joint is often helpful. Inadequate pre-operative planning can lead to improper selection of the implants and/or incorrect implant positioning.

CAUTION:

Preoperative planning provides an initial estimation of the final situation but cannot conclusively determine the most adequate size to be used. The ultimate decision can only be taken intraoperatively.

As general rule, the hip prosthesis stem should be measured in such a way that a positive-fit fixation of the prosthesis is created over a sufficient length in vital bone. To this end, it is necessary to make allowance for reaming the femoral canal. Achieving anatomically appropriate head-neck length is of paramount importance. The MP Reconstruction System offers different offsets with changing CCD angles. This combined with femoral heads with up to four head-neck lengths allows the surgeon great flexibility.

The surgical instructions below for reconstructing a damaged hip joint with the MP Reconstruction System describe an idealized surgical situation. However, every procedure has individual particularities, and the surgeon decides during the surgery which method can be expected to achieve the best outcome in the each case.

In-situ implants and the bone cement must be completely removed before implanting an MP Reconstruction System.

INFORMATION:

Preoperative planning may be time-consuming, but the time spent results in better intraoperative support and enhanced quality assurance.

Preoperative planning supports optimal surgical outcomes by ensuring the most appropriate implant selections for the patient. The key objectives involved are the correct positioning of the central rotational point of the hip, correct leg length and finally preservation or restoration of sufficient soft tissue tension by avoiding medialisation of the femur.

Planning should ideally be based on two X-rays: an AP film of the pelvis and a mediolateral X-ray of the hip to be revised. When performing the pelvic X-ray it is important to ensure that:

1. Both femurs are shown adequate length, to show the preoperative geometry.
2. The femurs are straight and parallel and, if possible, internally rotated approximately 5° in that position.
3. Key landmarks needed for planning are visible: the inferior margins of the obturator foramen and of the acetabular teardrop.

When evaluating the X-rays, it is important calculate the magnification factor. Two factors are decisive (Fig. 1):

1) Focal distance

Focal spot X-ray tube $\leftarrow x \rightarrow$ Film cassette
 A focal distance of 100 cm gives magnification of about 10%.

2) Object film distance

Femoral axis $\leftarrow x \rightarrow$ Film cassette

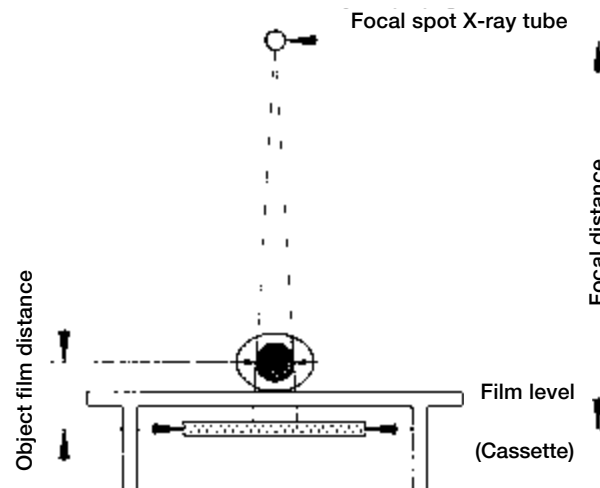

Fig. 1

The surgical instructions below for reconstructing a damage hip joint using the MP Reconstruction System depict an idealized surgical situation. However, every procedure has individual particularities, and the surgeon decides during the surgery which method can be expected to achieve the most success in the current case.

Reaming of Medullary Canal

The reaming of the femoral canal begins with a tapered reamer corresponding to the planned hip prosthesis stem length (A), but with a diameter 1-2 sizes smaller than the planned stem diameter; this does not apply when using the smallest diameter (Ø12 mm 160-21 0 mm).

The reaming depth is determined by the position of the ring markings on the shaft of the tapered reamer. The ring markings refer to the stem length. The marking should be in relation to an anatomical landmark on the bone, determined during the preoperative planning.

If no proximal spacers are used, the position of the lower marking ring should be at the medial level of the original femoral neck resection (Fig. 2). This landmark can be easily identified on the X-ray, enabling a reference marking to be determined for the surgery.

INFORMATION:

The fourth ring is approximately at the level of the tip of the greater trochanter, and the lower ring a thumb's breadth above the lesser trochanter – always without the use of proximal spacers.

The tapered reamers should only ever be screwed into the femoral canal as far as indicated by the position of the marking ring to the specified landmark.

The reaming must be performed carefully. The tapered reamer must not become hot to the touch. For this reason, we urgently recommend performing the reaming by hand.

The last tapered reamer is used to prepare the medullary canal until contact is made with the endosteal cortical bone until adequate endosteal engagement is achieved (Fig. 2).

In addition, the surgeon can check whether contact surface is sufficiently large when the last tapered reamer is carefully removed clockwise. Bone particles on the tapered reamer shaft can provide information on the reaming distance.

The last reaming step must always be performed with a diameter identical to that of the implant stem. For example, if an implant with Ø18 mm is used, the last reaming step must be performed with a Ø18 mm tapered reamer.

Reaming depth without proximal spacer(s)

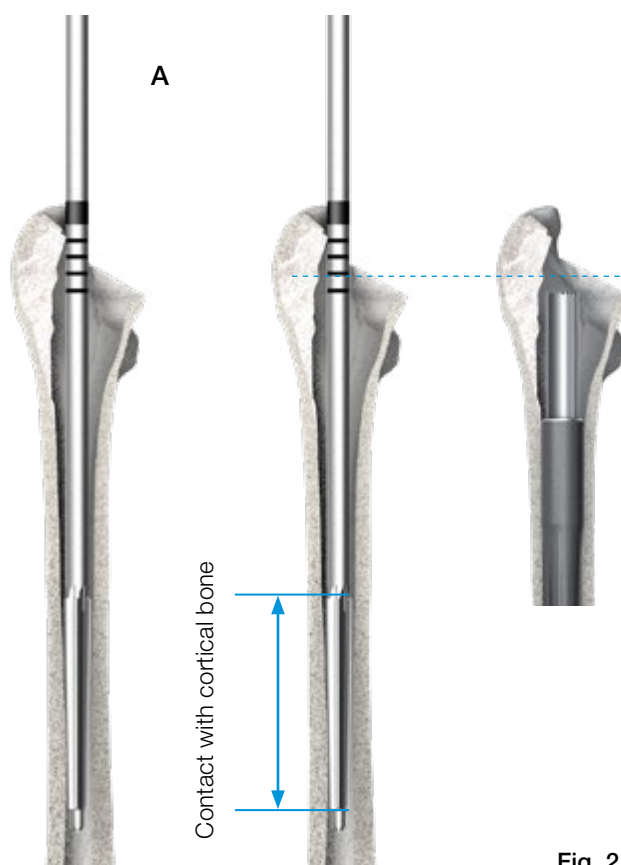

Fig. 2

Insertion of the Hip Prosthesis Stem

The selected stem of the MP Reconstruction System (B), which corresponds to the size of the last tapered reamer used, is screwed tightly to the **inserter for stems** (C) (Fig. 4).

The line marking on the stem identifies the side of the stem which indicates the 3° angle (Fig. 4, center). The orientation of the marking is used for a better overview when inserting the stem. The arrow on the striking surface now indicates where the angle of the stem is. This makes it possible to insert the stem into the femoral canal precisely aligned to the natural curvature of the femur (Fig. 4/with curvature).

The stem is then carefully driven in to the final depth using a mallet. The final position must be verified by means of radioscopic control (Figs. 5 and 6).

The stem must not be driven in deeper than intended in the preoperative planning.

Should it prove impossible to achieve stable fixation of the stem at the intended depth due to poor bone quality, any shortening of the leg that results from driving the stem in deeper can be compensated by using proximal spacers of up to 30 mm (10 mm, 20 mm, or 20+10 mm).

Intentional lengthening of the leg is also possible with a proximal spacer (see Fig. 3).

INFORMATION:

Secure fixation of the MP hip prosthesis stem in the medullary canal is always given utmost priority.



Fig. 3



Fig. 4

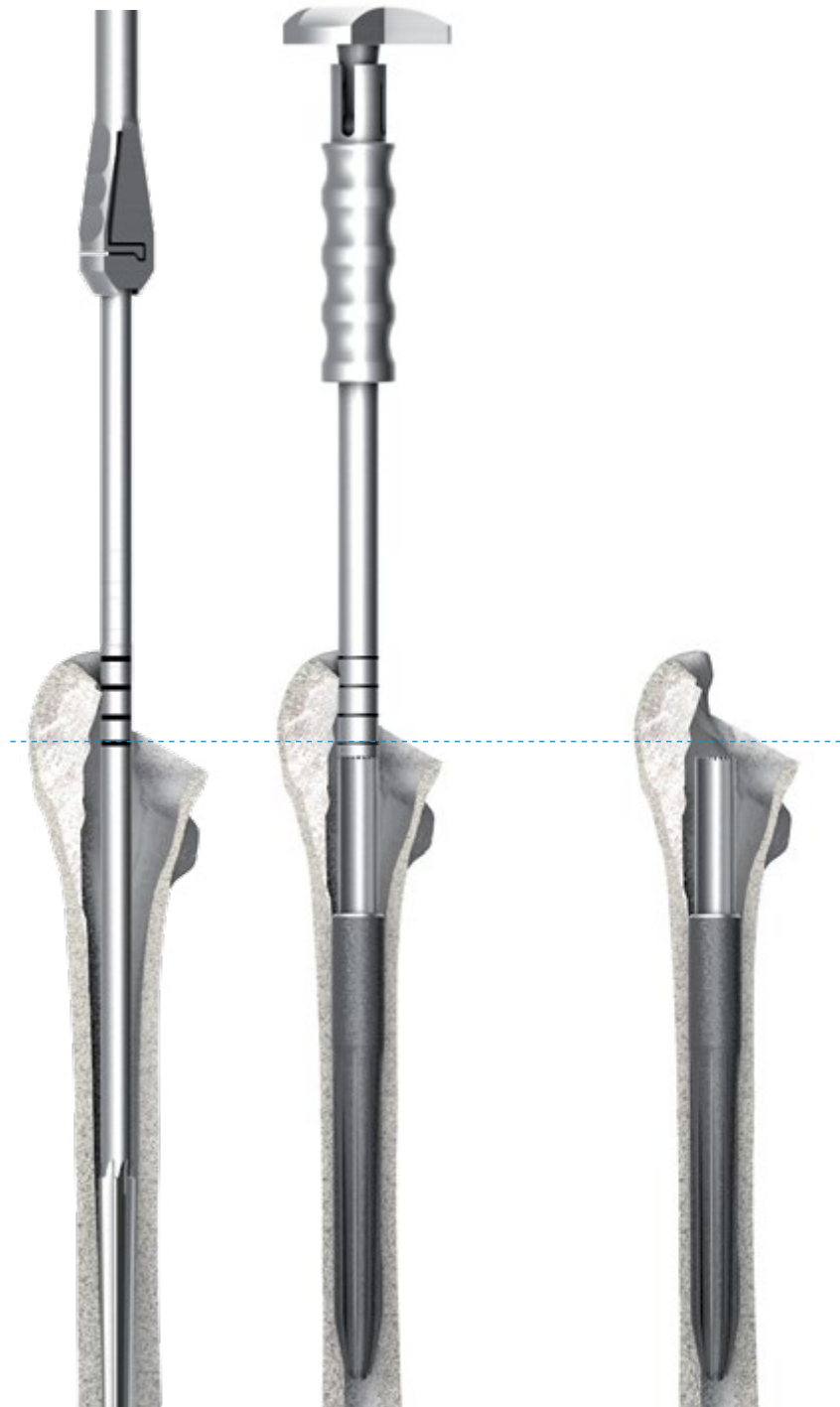

Fig. 5

Fig. 6



Fig. 7

Preparation of the proximal femur

If required, the Tubular Reamer is used to prepare the implant bed for the neck segment (Fig. 7).

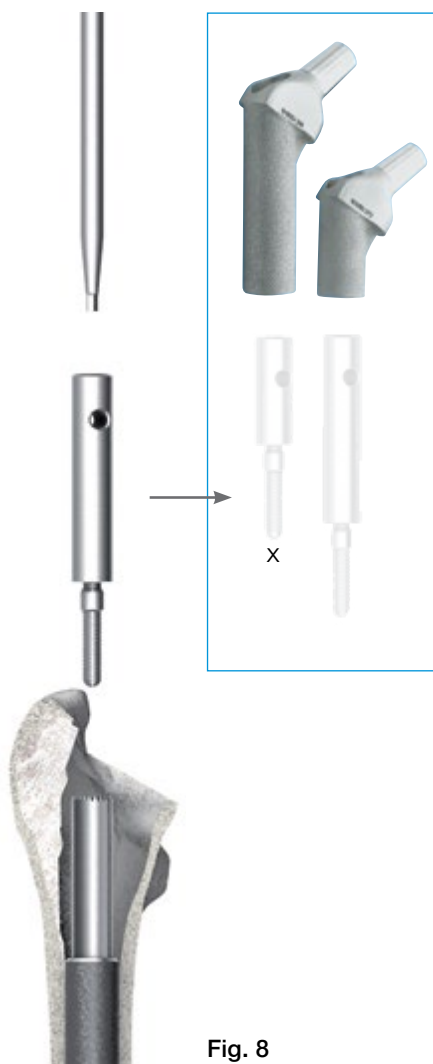

Fig. 8

There are **two reamer guides** available for positioning the reamer on the in-situ stem. Their length must be selected according to the neck segment being used (Fig. 8).

Short reamer guide --> long neck segment (x)
Long reamer guide --> short neck segment (y)

The reamer guide can be screwed into the stem by hand or using the hex screwdriver.

The reamer guide also serves as a stop to avoid the teeth of the tubular reamer from coming into contact with the edge of the lower portion of the stem.

Irrigation is recommended to avoid overheating of the bone.

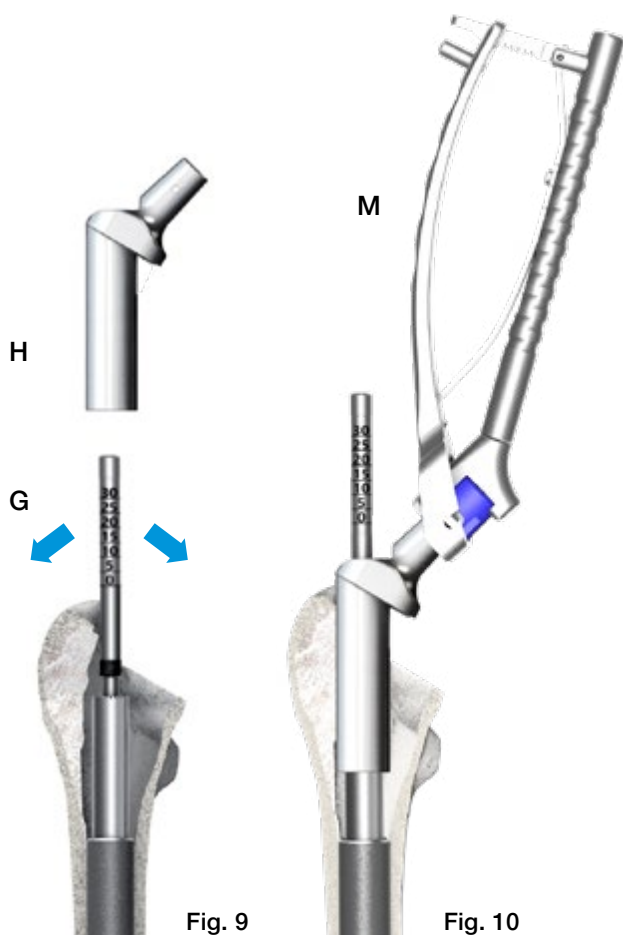

Trial Reduction

The **guide rod** (G), which simplifies positioning of the **trial neck segment** (H) and, where used, the trial proximal spacers, is screwed into the thread of the implanted stem and fixed in place using a hex screwdriver (K) (Fig. 9).

For the functional test, a **trial neck segment** (H) is pushed over the **guide rod** (G) and onto the implanted hip prosthesis stem by hand or by using the insertion forceps (M) (Fig. 10). The teeth inside the trial neck segment must fit into the tothing on the stem.

The trial neck segment can be simply tested by turning it backward and forward.

The final position of the neck segments on the prosthesis stem within the bone is indicated by the scale within the window of the neck inserter. If the markings of the guide rod and neck inserter touch, the height of the spacers used is shown in the window of the neck inserter. If no spacer is used the "0" line is referenced, if spacers are used, the corresponding line of reconstruction height of the spacers is used as reference. E.g. if a 10 mm spacer is used, the reference line is "10" (Fig. 11). The guide rod is removed and the neck fixed with a trial screw (Q) using the hex screwdriver.

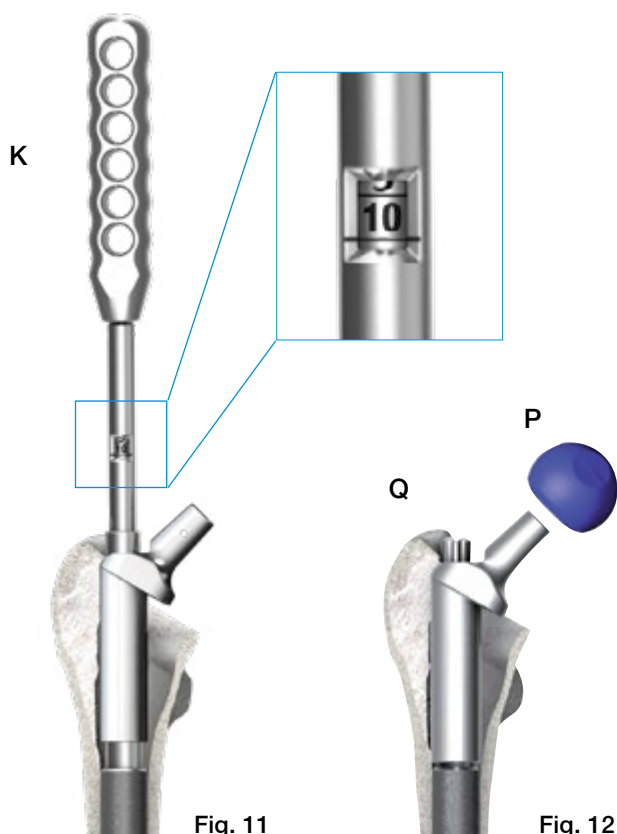

If no spacer or spacers up to +10 mm are required, the short screw is used. If spacers are used from +10 mm to +30 mm the long screw is used.

INFORMATION:

Usually, the acetabular cup is implanted before the stem component so that trial reduction can now be done.

Various Trial Heads (P) are used to check for optimal offset rotation, correct leg length and adequate stability. The range of motion is also checked in order to exclude any impingement of bone or implant with the acetabular cup (Fig. 12).

The trial components are removed.

Leg Length and Lateralization

Leg length can be corrected by 10 mm, 20 mm, or 30 mm (combination of 10 mm and 20 mm proximal spacers) by using trial proximal spacers (Fig. 3).

Fine tuning of the leg length and different lateralization of the hip prosthesis stem can be achieved by selecting:

- Neck segment with 126° or 135° CCD angle in standard neck length or XXL neck length or
- Trial head with suitable head-neck length

INFORMATION:

A long trial neck segment is obligatory when trial proximal spacers are used.

Short trial neck segments must not be used with trial proximal spacers (Fig. 14).

Rotation

The rotation angle can be corrected by turning the trial neck segment after loosening the fixation screw. The desired position should then be marked on the bone so that the final neck segment can be positioned correctly.

INFORMATION:

A short trial fixation screw is required if no trial proximal spacer or a 10 mm trial proximal spacer is used. If a 20 mm trial proximal spacer, or a combination of a 20 mm and a 10 mm proximal spacer, is used, then only the long trial fixation screw may be used (Fig. 13).

Use of a Longer Trial Neck Segment

Replacing an originally used 35 mm trial neck segment with a 65 mm trial neck segment can require the use of the tubular reamer due to the longer tubular neck of the 65 mm segment.

Once the leg length, anteversion and joint stability have been checked, the trial prostheses can be removed.

Expansion Bolt length)

Proximal spacers (trial + implant)

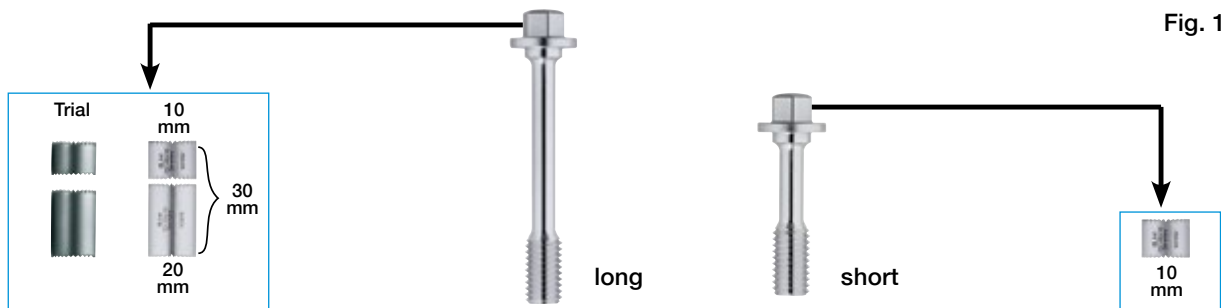

Fig. 13

Neck segments (trial + implant)

Proximal spacers (trial + implant)

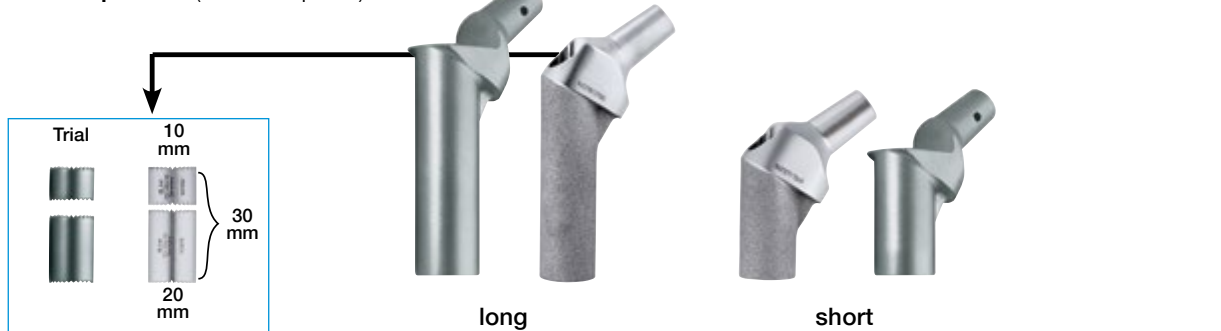

Fig. 14

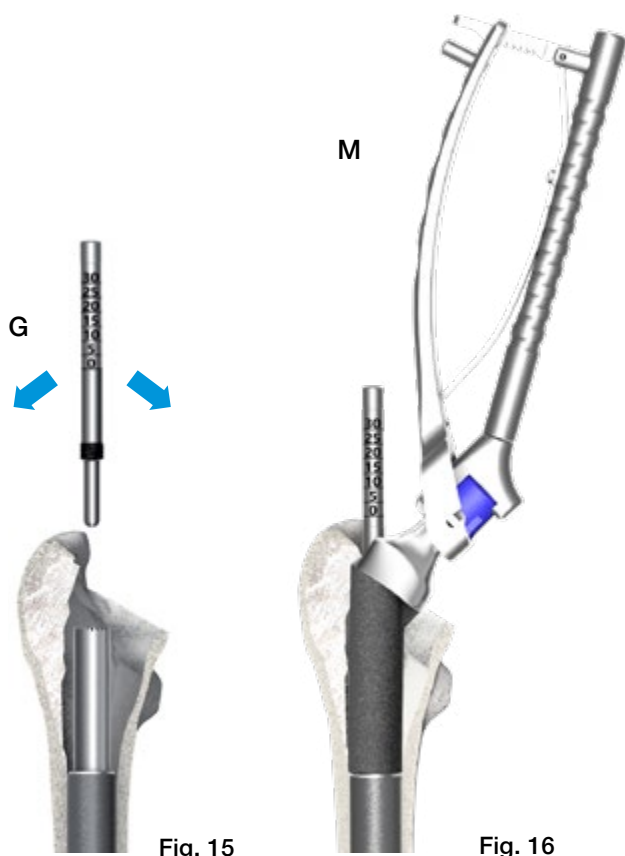

Fig. 15

Fig. 16

Final Assembly

Implantation of neck segment

Insert the guide rod (G) into the stem using the hex screwdriver (Fig. 15). The neck segment is then slid over the guide rod onto the stem either by hand or by using the insertion forceps (M). The neck can be driven into its final position with subtle hammer strokes, using the neck inserter (K) (Fig. 17). If spacers are used, spacers are slid over the guide rod before inserting the neck segment.

INFORMATION:

If using any spacers during surgery only the 65 mm neck segment can be used. The 35 mm neck segment can only be used without spacers.

The final position of the neck segments on the prosthesis stem within the bone is indicated by the scale within the window of the neck inserter. If the markings of the guide rod and neck inserter touch, the height of spacers used is shown in the window of the neck inserter. If no spacer is used the "0" line is referenced, if spacers are used, the corresponding line of reconstruction height of the spacers is used as reference. E.g. if a 10 mm spacer is used, the reference line is "10" (Fig. 17).

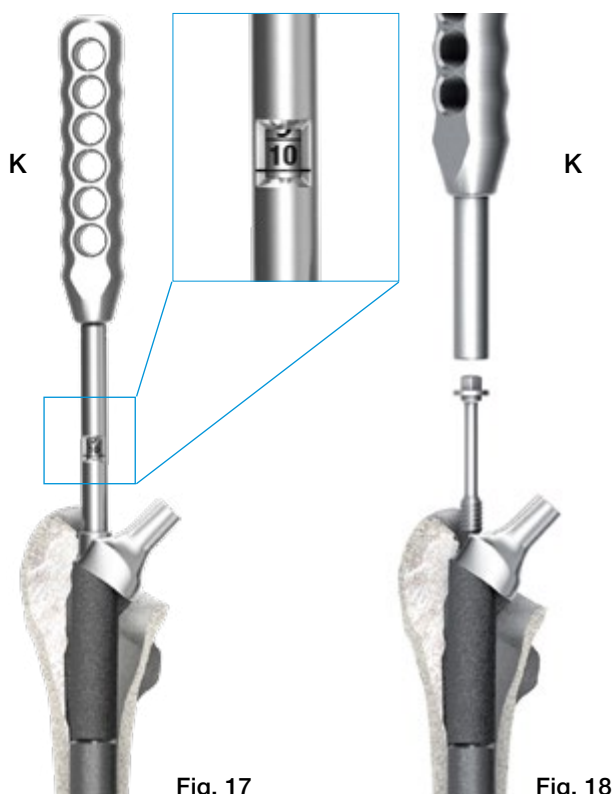

Fig. 17

Fig. 18

The guide rod is removed and the neck fixed with the expansion bolt, using the neck inserter / screwdriver (K) (Fig. 18).

If no spacer or spacers up to +10 mm are used, the short expansion bolt is used. If spacers are used from +20 mm to +30 mm the long expansion bolt is used.

A final trial reduction can be conducted using a plastic trial head. If necessary, the rotation can now be corrected by loosening the expansion bolt again. The guide rod is then reinserted into the stem and the neck segment can be rotated by slightly lifting it up before rotating. Then the steps of inserting and checking are repeated as described above.

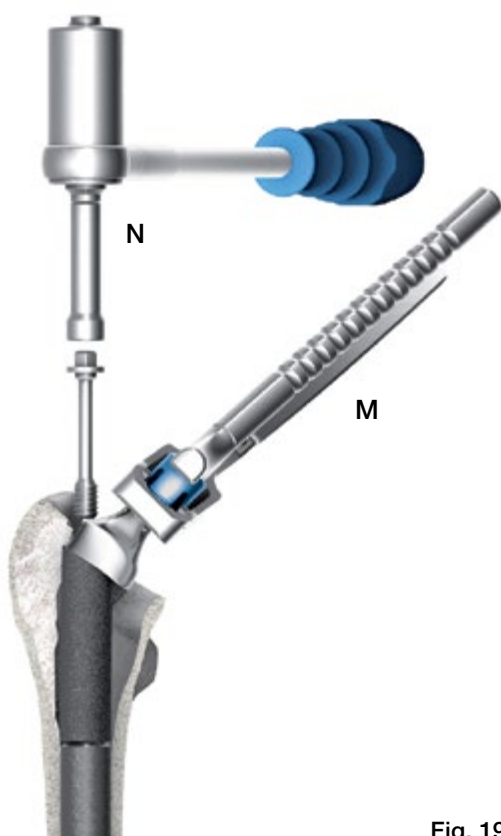

Fig. 19

Final assembly of the implant

After the expansion bolt is hand tightened with the neck inserter / screwdriver (K), the expansion bolt is tightened with the torque wrench (N). When tightening the expansion bolt with the torque wrench, the insertion forceps (M) is used as a counter torque by gripping the neck segment over the trunion. Once the necessary torque is reached, the torque wrench emits a loud snap (Fig. 19).

INFORMATION:

The taper caps of the insertion forceps must be checked for damage before use.

CAUTION:

LINK implants and expansion bolts can only be used once. It is not possible to reuse them because no expansion occurs when the bolt is tightened a second time. The torque wrench must never be used to loosen screw connections, as this could have a negative effect on its function.

INFORMATION:

There are two screw lengths available:
41 and 61 mm

- Use of the short screw (41 mm):
no proximal spacer or a 10 mm proximal spacer
- Use of the long screw (61 mm):
a 20 mm proximal spacer or combination of a 10 mm and a 20 mm proximal spacer (30 mm in total)



Fig. 20

Attaching the prosthesis head

The taper of the neck segment is carefully cleaned and dried. This is particularly important with ceramic heads. Then the head is attached by hand with a rotational movement, applying axial pressure. To finish, the driver is used to tap the prosthesis head into position (Fig. 20).

Final reduction of the joint

After cleaning the joint surfaces, the joint is reduced. The wound is closed in layers.

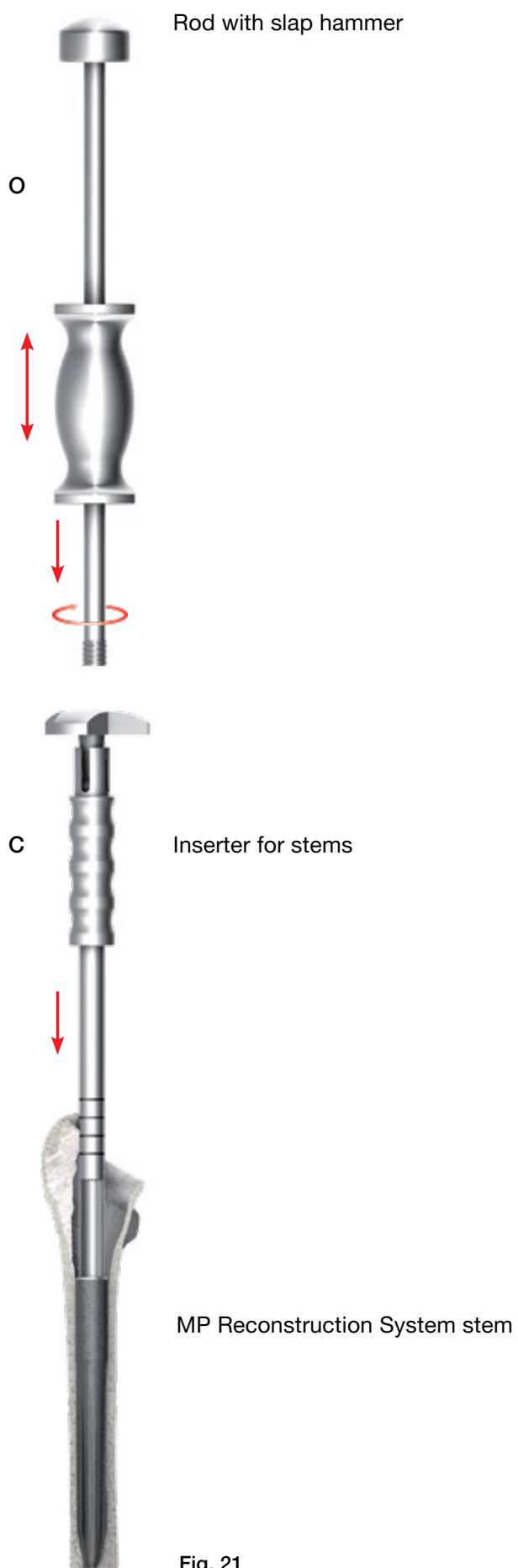

Stem Extraction

Should it prove necessary to remove the stem during the surgery or later revision, the inserter (C) is mounted on the in-situ **stem** and screwed to the **rod with slap hammer (O)**.

The stem can be driven out of the medullary canal safely by applying measured blows to the upper stop with the slap hammer (Fig. 21).

Fig. 21

Procedure

If use of a cemented stem is planned, the 180 mm long MP trial stems (134-070/00), the additional instrument set for the cemented surgical technique (134-110/00), and an insertion sleeve, UHMWPE (134-212/00) are required in addition to the basic instrument set.

The medullary canal is prepared with ball reamers or the standard reamers to accept the hip prosthesis stem. It is recommended to start with the smallest diameter and open up the medullary canal millimeter by millimeter until contact with the cortical bone is identified distally around the circumference.

To achieve an even cement coating of 1 mm all the way around, the medullary space must be excavated to a diameter at least 2 mm larger than the stem used.



It might be necessary to clear the proximal femur to allow for the use of the plastic sleeve. If this can't be achieved using the start reamer please proceed with the following steps.

Once the medullary space has been prepared to the required diameter, a trial stem measuring 180 mm in length is inserted, corresponding to the diameter of the last medullary space reamer used.

The trial stem is secured on the inserter (C) as described on page 06, and then inserted up to the planned proximal marking (Fig. 22).

CAUTION:
Do not exert too much pressure, as the trial stem is not intended to achieve a press fit, and can thus be driven further into the femur than planned.

Fig. 22

The **short** reamer guide is screwed onto the trial stem as described on page 08, and then the proximal bone reamed for the cemented preparation with the tubular reamer (134-211/00) (Fig. 23).



Fig. 23

The reamer guide is then unscrewed again and the trial stem is removed from the femur with the aid of the inserter. This can be done using the slide hammer.

INFORMATION:

The plastic sleeves must be checked for damage before use.

The plastic sleeve is screwed to the insertion sleeve, pushed onto the proximal section of the implant stem, and then screwed to the inserter (Fig. 24).

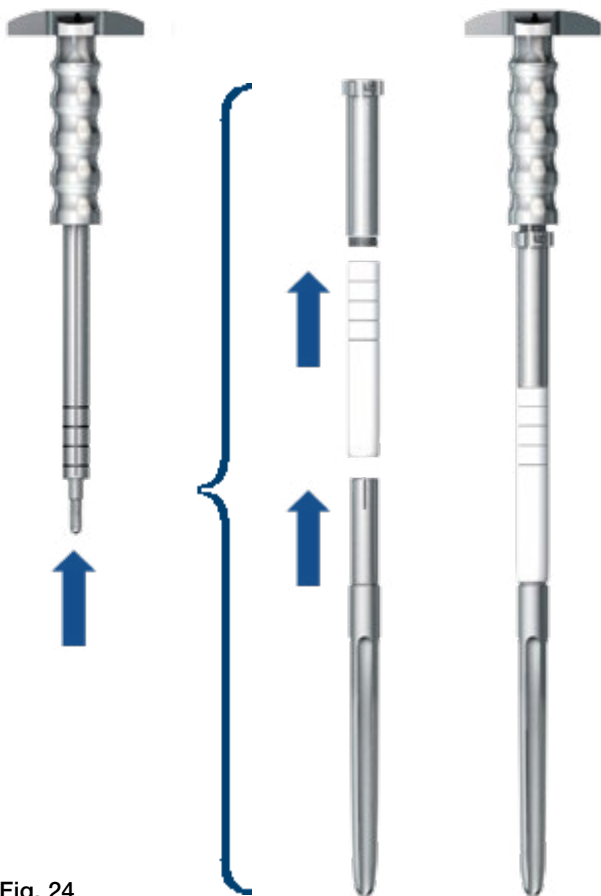

Fig. 24

The medullary space is then sealed with a bone dowel or a medullary plug a little below the intended position of the stem tip. Following application of the cement, the hip prosthesis stem is introduced into the medullary space. The markings on the plastic sleeve correspond to the markings on the inserter used in the uncemented surgical technique. As such, the lowest line marks the proximal end of the stem.

CAUTION:

When applying the cement, it is essential to ensure secure fixation of the distal end of the stem. Proximal oozing of the cement should be avoided and any escaping cement removed before it sets.

The stem is held in the required position with the inserter until the cement sets. The plastic sleeve prevents excess cement from coming into contact with the proximal portion of the stem (Fig. 25). Once the cement has completely set, the inserter is disconnected from the implant and removed along with the plastic sleeve.



To remove the plastic sleeve, the extractor is inserted in the sleeve and the bayonet mount is locked. The plastic sleeve can now be twisted free from the cement and removed (Fig. 25).

Fig. 25



The reamer guide is screwed onto the hip prosthesis stem again and the further preparation of the proximal femur can continue as shown on page 09.

Any excess cement is then removed from the area of the proximal femur at the next reaming stage and with the tubular reamer (134-200/00).

INFORMATION:

We recommend checking the cement application and the associated prosthesis positioning with radiosopic control.

Fig. 26

Hip Prosthesis Stems



INFORMATION:
160 mm long stems must only be used with short neck segments and without proximal spacers.

Hip Prosthesis Stems, uncemented

MAT Tilastan-S

REF microporous	Prox. stem-Ø mm	Dist. stem-Ø mm	Length mm
172-916/12	12.0	10.0	160
172-916/14	14.0	12.0	160
172-916/16	16.0	14.0	160
172-916/18	18.0	16.0	160
172-916/20	20.0	18.0	160
172-916/22	22.5	21.0	160
172-916/25	25.0	23.0	160
172-918/12	12.0	10.0	180
172-918/14	14.0	12.0	180
172-918/16	16.0	14.0	180
172-918/18	18.0	16.0	180
172-918/20	20.0	18.0	180
172-918/22	22.5	21.0	180
172-918/25	25.0	23.0	180
172-921/12	12.0	10.0	210
172-921/14	14.0	12.0	210
172-921/16	16.0	14.0	210
172-921/18	18.0	16.0	210
172-921/20	20.0	18.0	210
172-921/22	22.5	21.0	210
172-921/25	25.0	23.0	210
172-925/14*	14.0	11.0	250
172-925/16	16.0	13.0	250
172-925/18	18.0	15.0	250
172-925/20	20.0	17.0	250
172-925/22	22.5	19.0	250
172-925/25	25.0	22.0	250
172-929/14*	14.0	9.0	290
172-929/16	16.0	11.0	290
172-929/18	18.0	13.0	290
172-929/20	20.0	15.0	290
172-929/22	22.5	18.0	290
172-929/25	25.0	20.0	290
172-930/14*	14.0	8.0	330
172-930/16	16.0	10.0	330
172-930/18	18.0	12.0	330
172-930/20	20.0	14.0	330
172-930/22	22.5	16.0	330
172-930/25	25.0	19.0	330

*Stems combined with a neck/head combination creating an offset higher than 40.0 mm could not be proven to fulfil the mechanical normative requirements

Hip Prosthesis Stems

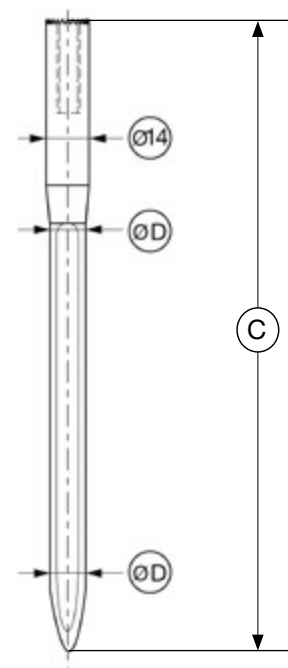

Modular Revision Stems, cemented, anatomically curved
 [MAT] EndoDur (CoCrMo alloy)

[REF]	for stem length (C) mm	Stem Ø (D) mm
172-900/12	200	12
172-900/14	200	14
172-900/16	200	16
172-901/12	240	12
172-901/14	240	14
172-901/16	240	16
172-902/12	280	12
172-902/14	280	14
172-902/16	280	16
172-903/12	320	12
172-903/14	320	14
172-903/16	320	16

Stems of length 240 mm or longer combined with a neck/head combination creating an offset higher than 43.2 mm could not be proven to fulfil the mechanical normative requirements.

Neck Segments

Standard Neck Segments

MAT *TiLastan*, microporous, taper 12/14 mm

REF	Length (mm)	CCD angle	Offset (mm)
172-964/26	65	126°	31
172-964/35	65	135°	29
172-965/26	35	126°	31
172-965/35	35	135°	29



XXL Standard Neck Segments (with 40 mm femoral axis offset)

MAT *TiLastan*, microporous, taper 12/14 mm

REF	Length (mm)	CCD angle	Offset (mm)
172-984/26	65	126°	40*
172-984/35	65	135°	40*
172-985/26	35	126°	40*
172-985/35	35	135°	40*



Neck Segments with Suture Holes

MAT *TiLastan*, microporous, taper 12/14 mm

REF	Length (mm)	CCD angle	Offset (mm)
99-0984/30	65	126°	31
99-0984/32	35	126°	31



XXL Neck Segments with Suture Holes

MAT *TiLastan*, microporous, taper 12/14 mm

REF	Length (mm)	CCD angle	Offset (mm)
99-0984/26	65	126°	40*
99-0984/28	35	126°	40*



Proximal Spacers and Expansion Bolts

Proximal Spacers

MAT CoCrMo alloy

REF	Length (mm)
172-950/10	10
172-950/20	20



Expansion Bolts

MAT CoCrMo alloy

REF	Length mm
172-947/38	41
172-947/58	61



Possible Combinations:

Neck Segments Length (mm)	Proximal Spacers		Expansion mm	Expansion bolt Length mm
	10 mm	20 mm		
65	-	-	0	41
65	10	-	10	41
65	-	20	20	61
65	10	20	30	61
35 ¹⁾	-	-	-	41

1) Combination with proximal spacer(s) not possible.



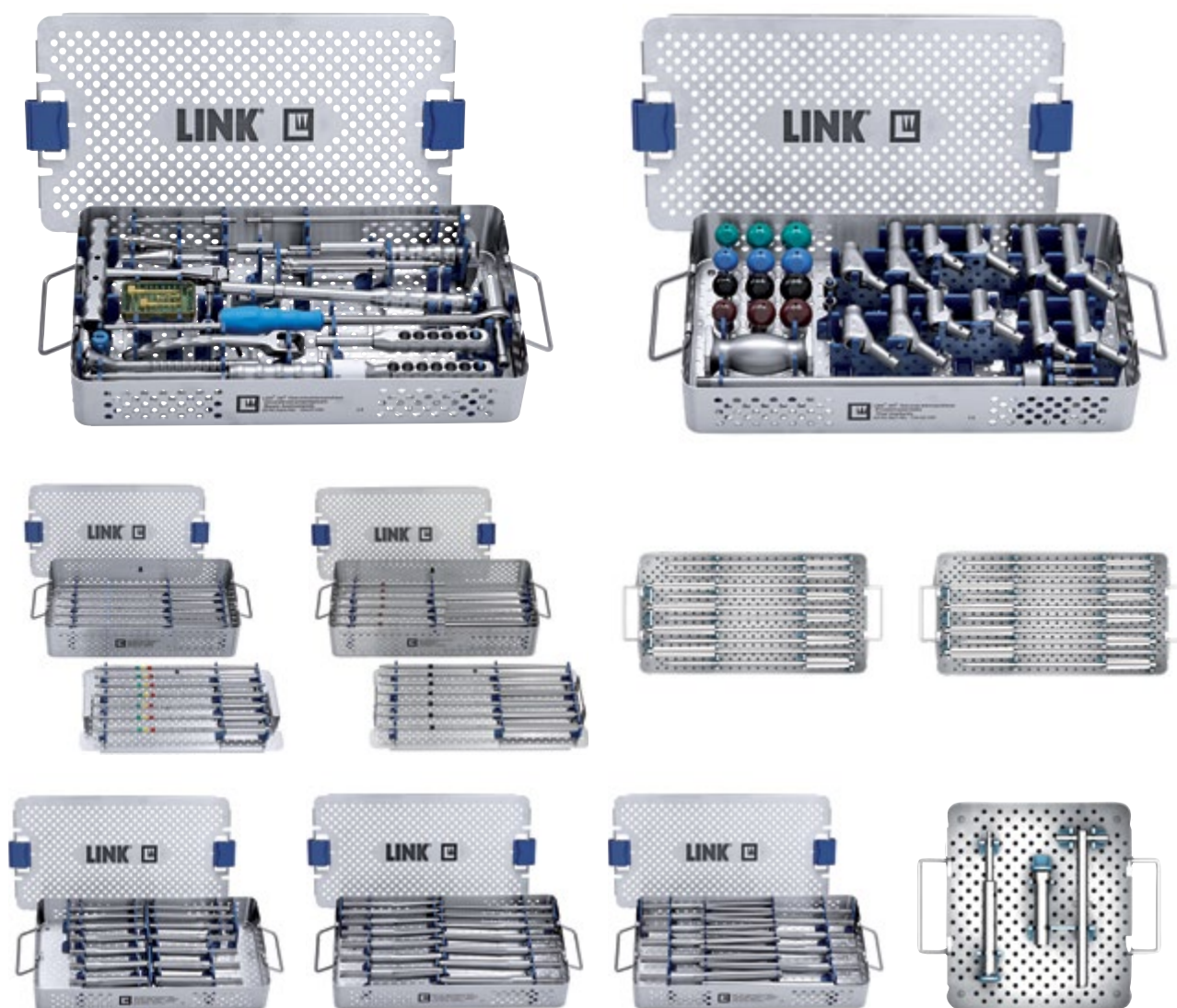

Additional Instrument Set

REF	Complete instrument set (incl. trays 1, 2, 3 and 4)
	Set in 4 instrument trays, comprising:
134-010/00	Instrument tray 1 , basic instrument set
134-020/00	Instrument tray 2 , trial implants
134-030/00	Instrument tray 3 , tapered reamers 160-250 mm
134-040/00	Instrument tray 4 , tapered reamers 290-330 mm

REF	Additional instruments, trays 5, 6, 7, 8, 9 and 10
134-050/00	Instrument tray 5 , tapered reamers, uneven, 160-250 mm
134-060/00	Instrument tray 6 , tapered reamers, uneven, 290-330 mm
134-070/00	Instrument tray 7 , trial stems 160-180 mm
134-080/00	Instrument tray 8 , trial stems 210-250 mm
134-090/00	Instrument tray 9 , trial stems 290-330 mm
134-110/00	Instrument tray 10 , cemented technique

134-010/00 Instrument Tray 1, basic instrument set

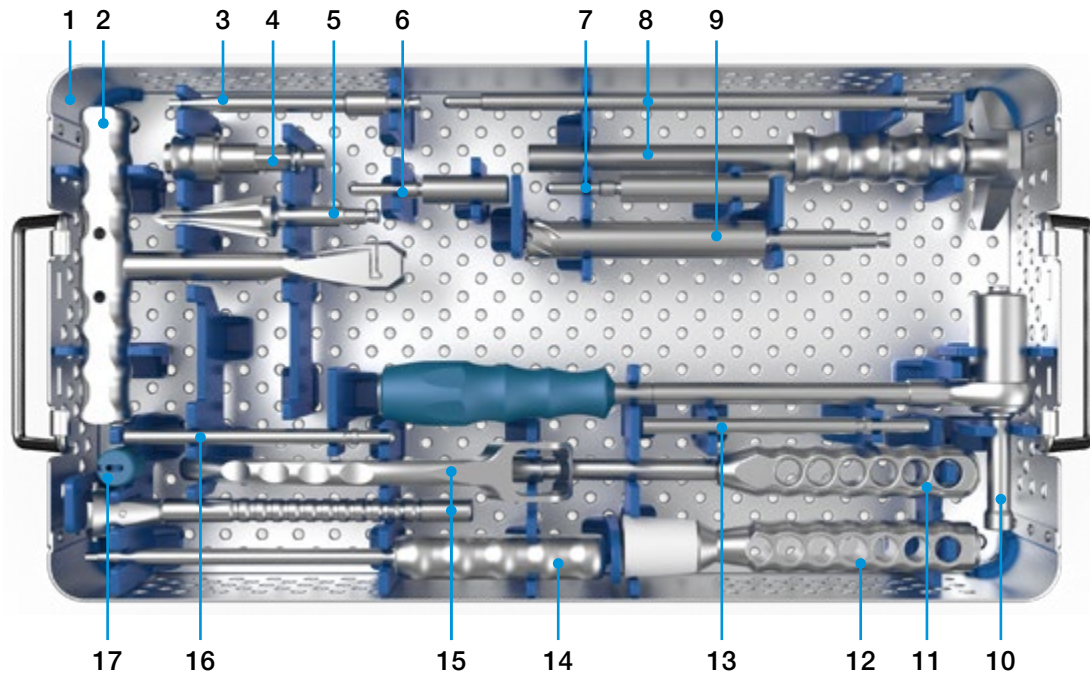

	REF	Description
1	134-011/00	Instrument tray 1, empty, 485 x 253 x 80 mm
2	15-6053/00	T-handle, Hudson
3	134-105/00	Screwdriver, size 3.5 mm, Hudson
4	16-3283/00 16-3284/00 16-3286/00	Adapter, optional Adapter, Hudson female / triangular male Adapter, Hudson female / AO male Adapter, Hudson female / Harris male
5	15-6037/00	Start drill
6	134-204/35	Reamer guide, for standard neck segment
7	134-204/65	Reamer guide, for short neck segment
8	134-210/00	Inserter for stems
9	134-200/00	Tubular reamer, Hudson
10	134-140/00	Torque wrench, size 8 mm, 380 mm
11	134-216/00	Neck inserter / screwdriver, hex 8 mm
12	130-600	Driver for prosthesis heads
13	134-215/00	Guide rod
14	64-8008/02	Screwdriver, size 3.5 mm
15	134-141/00	Insertion forceps for MP neck segments
16	134-215/01	Guide rod, short for MP stem, L 160 mm, Ø12 mm only
17	131-830/04	Taper cap

134-020/00 Instrument Tray 2, trial implants

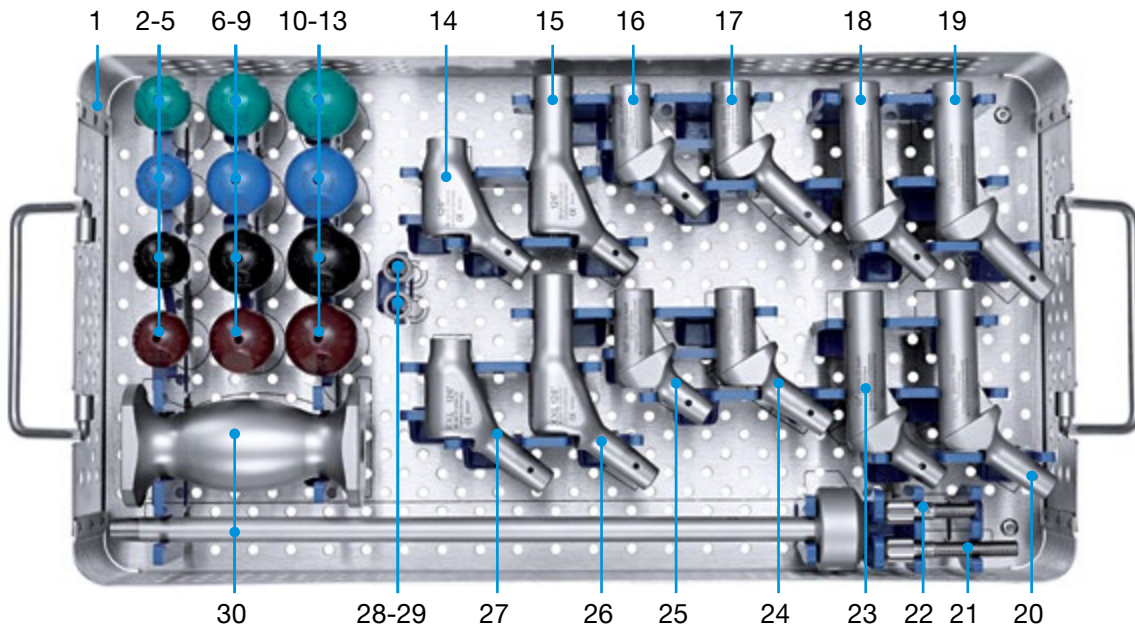

	REF	Description
1	134-021/00	Instrument tray 1, empty
2	175-928/11	Trial head, 28 mm, S
3	175-928/12	Trial head, 28 mm, M
4	175-928/13	Trial head, 28 mm, L
5	175-928/14	Trial head, 28 mm, XL
6	175-932/11	Trial head, 32 mm, S
7	175-932/12	Trial head, 32 mm, M
8	175-932/13	Trial head, 32 mm, L
9	175-932/14	Trial head, 32 mm, XL
10	175-936/11	Trial head, 36 mm, S
11	175-936/12	Trial head, 36 mm, M
12	175-936/13	Trial head, 36 mm, L
13	175-936/14	Trial head, 36 mm, XL
14	99-0984/33	Trial neck segment, 35 mm, 126° with suture hole
15	99-0984/31	Trial neck segment, 65 mm, 126° with suture hole
16	131-395/35	Trial neck segment, 35 mm, 135°
17	131-393/35	Trial XXL neck segment, 35 mm, 135°
18	131-396/35	Trial neck segment, 65 mm, 135°
19	131-394/35	Trial XXL neck segment, 65 mm, 135°
20	131-394/26	Trial XXL neck segment, 65 mm, 126°
21	134-100/61	Trial fixation screw, long
22	134-100/41	Trial fixation screw, short
23	131-396/26	Trial neck segment, 65 mm, 126°
24	131-393/26	Trial XXL neck segment, 35 mm, 126°
25	131-395/26	Trial neck segment, 35 mm, 126°
26	99-0984/27	Trial XXL neck segment, 65 mm, 126° with suture hole
27	99-0984/29	Trial XXL neck segment, 35 mm, 126° with suture hole
28	131-398/10	Trial proximal spacer, 10 mm
29	131-398/20	Trial proximal spacer, 20 mm
30	317-661	Threaded rod with slap hammer

134-030/00 Instrument Tray 3, tapered reamers 160-250 mm

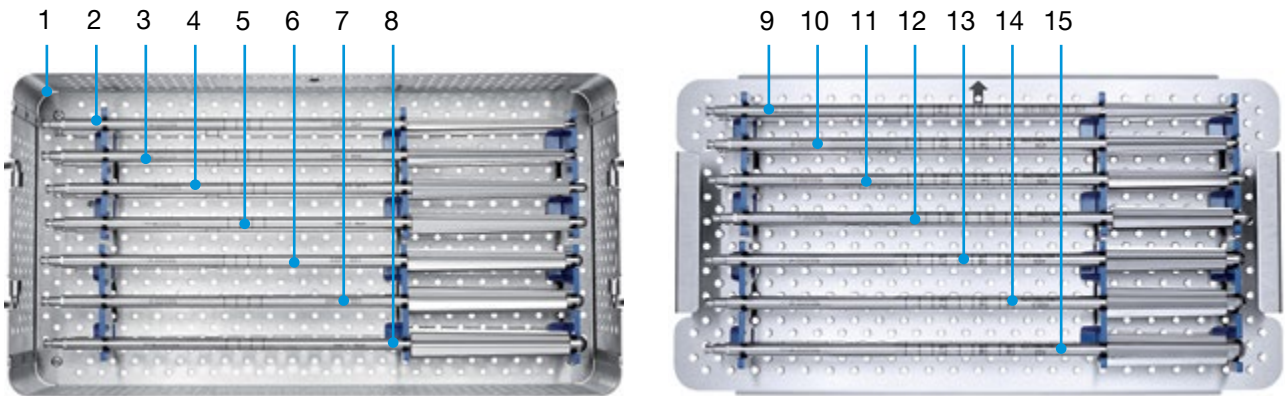

	REF	Description
1	134-031/00	Instrument tray 3, empty
2	134-600/00	Tapered reamer, Ø 12 mm, for stem size 250 mm
3	134-600/01	Tapered reamer, Ø 14 mm, for stem size 250 mm
4	134-600/02	Tapered reamer, Ø 16 mm, for stem size 250 mm
5	134-600/03	Tapered reamer, Ø 18 mm, for stem size 250 mm
6	134-600/04	Tapered reamer, Ø 20 mm, for stem size 250 mm
7	134-600/05	Tapered reamer, Ø 22.5 mm, for stem size 250 mm
8	134-600/06	Tapered reamer, Ø 25 mm, for stem size 250 mm
9	134-500/00	Tapered reamer, Ø 12 mm, for stem size 160-210 mm
10	134-500/01	Tapered reamer, Ø 14 mm, for stem size 160-210 mm
11	134-500/02	Tapered reamer, Ø 16 mm, for stem size 160-210 mm
12	134-500/03	Tapered reamer, Ø 18 mm, for stem size 160-210 mm
13	134-500/04	Tapered reamer, Ø 20 mm, for stem size 160-210 mm
14	134-500/05	Tapered reamer, Ø 22.5 mm, for stem size 160-210 mm
15	134-500/06	Tapered reamer, Ø 25 mm, for stem size 160-210 mm

134-040/00 Instrument Tray 4, tapered reamers 290-330 mm

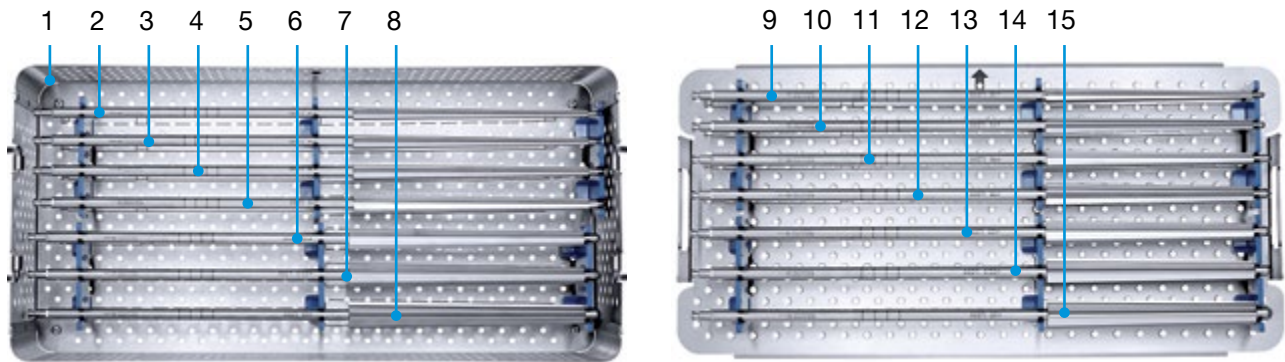

	REF	Description
1	134-041/00	Instrument tray 4, empty
2	134-800/00	Tapered reamer, Ø 12 mm, for stem size 330 mm
3	134-800/01	Tapered reamer, Ø 14 mm, for stem size 330 mm
4	134-800/02	Tapered reamer, Ø 16 mm, for stem size 330 mm
5	134-800/03	Tapered reamer, Ø 18 mm, for stem size 330 mm
6	134-800/04	Tapered reamer, Ø 20 mm, for stem size 330 mm
7	134-800/05	Tapered reamer, Ø 22.5 mm, for stem size 330 mm
8	134-800/06	Tapered reamer, Ø 25 mm, for stem size 330 mm
9	134-700/00	Tapered reamer, Ø 12 mm, for stem size 290 mm
10	134-700/01	Tapered reamer, Ø 14 mm, for stem size 290 mm
11	134-700/02	Tapered reamer, Ø 16 mm, for stem size 290 mm
12	134-700/03	Tapered reamer, Ø 18 mm, for stem size 290 mm
13	134-700/04	Tapered reamer, Ø 20 mm, for stem size 290 mm
14	134-700/05	Tapered reamer, Ø 22.5 mm, for stem size 290 mm
15	134-700/06	Tapered reamer, Ø 25 mm, for stem size 290 mm

Additional Instrument Set, tapered reamers 5 and 6, uneven

134-050/00 Instrument tray 5
Tapered reamers, uneven
160-250 mm

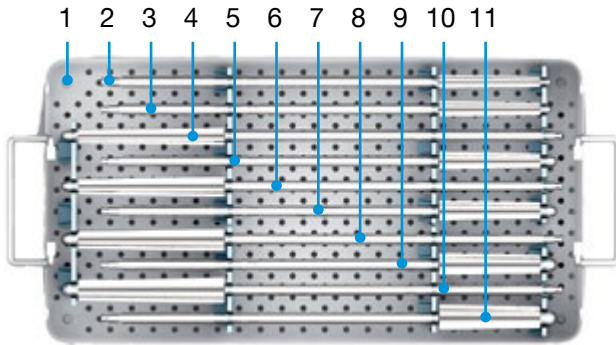

134-060/00 Instrument tray 6
Tapered reamers, uneven
290-330 mm

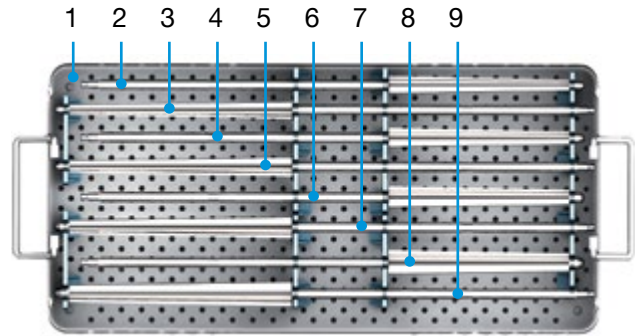

	REF	Description
1	134-051/00	Instrument tray 5, empty
2	134-500/07	Tapered reamer, Ø 13 mm for stem size 160-210 mm
3	134-500/08	Tapered reamer, Ø 15 mm for stem size 160-210 mm
5	134-500/09	Tapered reamer, Ø 17 mm for stem size 160-210 mm
7	134-500/10	Tapered reamer, Ø 19 mm for stem size 160-210 mm
9	134-500/11	Tapered reamer, Ø 21 mm for stem size 160-210 mm
11	134-500/12	Tapered reamer, Ø 24 mm for stem size 160-210 mm
4	134-600/09	Tapered reamer, Ø 17 mm for stem size 250 mm
6	134-600/10	Tapered reamer, Ø 19 mm for stem size 250 mm
8	134-600/11	Tapered reamer, Ø 21 mm for stem size 250 mm
10	134-600/12	Tapered reamer, Ø 24 mm for stem size 250 mm

	REF	Description
1	134-061/00	Instrument tray 6, empty
2	134-700/09	Tapered reamer, Ø 17 mm for stem size 290 mm
4	134-700/10	Tapered reamer, Ø 19 mm for stem size 290 mm
6	134-700/11	Tapered reamer, Ø 21 mm for stem size 290 mm
8	134-700/12	Tapered reamer, Ø 24 mm for stem size 290 mm
3	134-800/09	Tapered reamer, Ø 17 mm for stem size 330 mm
5	134-800/10	Tapered reamer, Ø 19 mm for stem size 330 mm
7	134-800/11	Tapered reamer, Ø 21 mm for stem size 330 mm
9	134-800/12	Tapered reamer, Ø 24 mm for stem size 330 mm

Additional Instrument Sets

134-070/00 Instrument Tray 7,
trial stems 160-180 mm

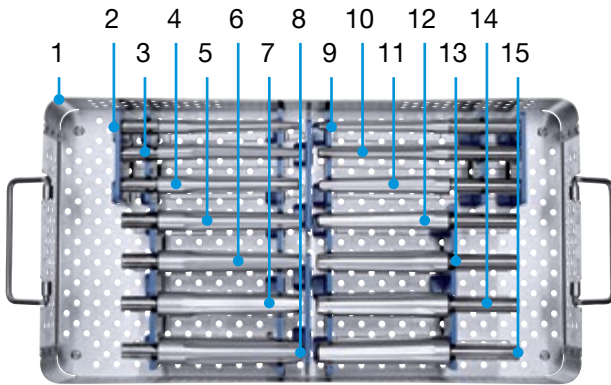

134-080/00 Instrument Tray 8,
trial stems 210-250 mm

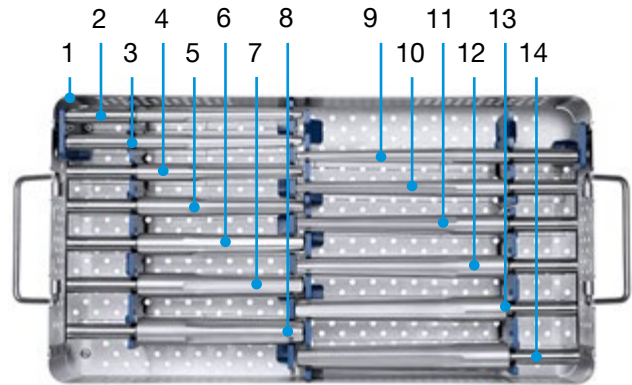

	REF	Description
1	134-071/00	Instrument tray 7, empty
2	134-900/12	Trial stem, Ø 12 mm, 160 mm
3	134-900/14	Trial stem, Ø 14 mm, 160 mm
4	134-900/16	Trial stem, Ø 16 mm, 160 mm
5	134-900/18	Trial stem, Ø 18 mm, 160 mm
6	134-900/20	Trial stem, Ø 20 mm, 160 mm
7	134-900/22	Trial stem, Ø 22.5 mm, 160 mm
8	134-900/25	Trial stem, Ø 25 mm, 160 mm
9	99-0155/12	Trial stem, Ø 12 mm, 180 mm
10	99-0155/14	Trial stem, Ø 14 mm, 180 mm
11	99-0155/16	Trial stem, Ø 16 mm, 180 mm
12	99-0155/18	Trial stem, Ø 18 mm, 180 mm
13	99-0155/20	Trial stem, Ø 20 mm, 180 mm
14	99-0155/22	Trial stem, Ø 22.5 mm, 180 mm
15	99-0155/25	Trial stem, Ø 25 mm, 180 mm

	REF	Description
1	134-081/00	Instrument tray 8, empty
2	99-0142/12	Trial stem, Ø 12 mm, 210 mm
3	99-0142/14	Trial stem, Ø 14 mm, 210 mm
4	99-0142/16	Trial stem, Ø 16 mm, 210 mm
5	99-0142/18	Trial stem, Ø 18 mm, 210 mm
6	99-0142/20	Trial stem, Ø 20 mm, 210 mm
7	99-0142/22	Trial stem, Ø 22.5 mm, 210 mm
8	99-0142/25	Trial stem, Ø 25 mm, 210 mm
9	99-0143/14	Trial stem, Ø 14 mm, 250 mm
10	99-0143/16	Trial stem, Ø 16 mm, 250 mm
11	99-0143/18	Trial stem, Ø 18 mm, 250 mm
12	99-0143/20	Trial stem, Ø 20 mm, 250 mm
13	99-0143/22	Trial stem, Ø 22.5 mm, 250 mm
14	99-0143/25	Trial stem, Ø 25 mm, 250 mm

Additional Instrument Set, cemented

**134-090/00 Instrument Tray 9,
trial stems 290-330 mm**

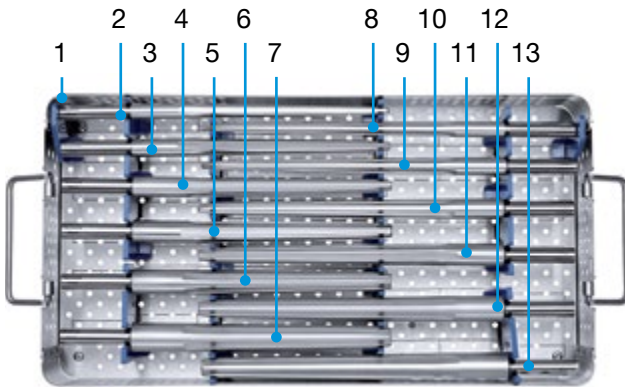

	REF	Description
1	134-091/00	Instrument tray 9, empty
2	99-0144/14	Trial stem, Ø 14 mm, 290 mm
3	99-0144/16	Trial stem, Ø 16 mm, 290 mm
4	99-0144/18	Trial stem, Ø 18 mm, 290 mm
5	99-0144/20	Trial stem, Ø 20 mm, 290 mm
6	99-0144/22	Trial stem, Ø 22.5 mm, 290 mm
7	99-0144/25	Trial stem, Ø 25 mm, 290 mm
8	99-0145/14	Trial stem, Ø 14 mm, 330 mm
9	99-0145/16	Trial stem, Ø 16 mm, 330 mm
10	99-0145/18	Trial stem, Ø 18 mm, 330 mm
11	99-0145/20	Trial stem, Ø 20 mm, 330 mm
12	99-0145/22	Trial stem, Ø 22.5 mm, 330 mm
13	99-0145/25	Trial stem, Ø 25 mm, 330 mm

134-110/00 Instrument Tray 10

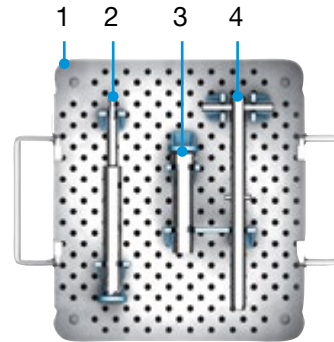

	REF	Description
1	134-111/00	Instrument tray 10, empty
2	134-211/00	Tubular reamer, Ø 19 mm
3	134-213/00	Insertion sleeve
4	134-214/00	Extractor

134-212/00 Insertion sleeve, MAT UHMWPE

Additional Instruments

(not included in instrument set)



Blade Chisel with Sheath, 250 mm

REF	Width mm	Working length mm
65-1700/20	20	65
65-1700/25	25	65

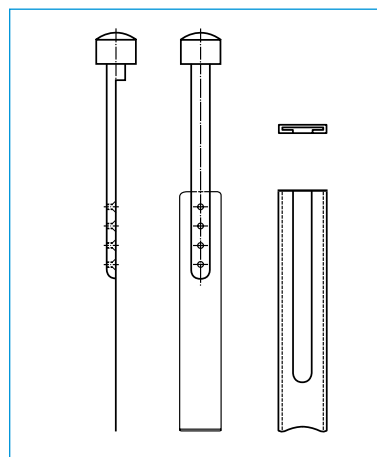

X-ray Templates

X-ray Templates for MP Reconstruction Prosthesis

110% natural size, taper 12/14 mm, set of 7 plates

(X-ray templates 120% natural size available on request)

REF	CCD angle	Head-Ø mm	Neck length	for stem length mm	Set
175-870/02	126°	32	Short (S)	160	7 plates
175-870/05	135°	32	Short (S)	160	7 plates
175-870/08	126°	32	Medium (M)	180	7 plates
175-870/11	135°	32	Medium (M)	180	7 plates
175-870/14	126°	32	Long (L)	210-330	7 plates
175-870/17	135°	32	Long (L)	210-330	7 plates

Cleaning and Care Instructions

Corresponding instructions for the instrument sets are available from info@link-ortho.com on request.

Ph. Lubinus, W. Klauser

The Revision Femur: A Potpourri of Options, A Modular Option for Proximal Bone Loss, Orthopaedics, Vol. 23 No. 9, Sept. 2000 ([H112](#))

A. Seth Greenwald, Paul D. Postak

The Influence of Modularity on the Endurance Performance of the LINK MP Hip Stem, Orthopaedic Research Laboratories, Cleveland, Ohio, Feb. 2001 ([H114](#))

F. Bellomo, L. Bertignone, L. Morino, P. Milano, E. Schiavone, M. Barale

LINK MP cementless distal fixation modular prosthesis for revision total hip arthroplasty, J Orthopaed Traumatol (2002) 2:121-124 ©Springer Verlag 2002 ([H118](#))

Daniel J. Berry, MD

Femoral Revision, Distal Fixation With Fluted, Tapered Grit-Blasted Stems The Journal of Arthroplasty, Vol. 17 No. 4 Suppl 1, June 2002 ([H121](#))

Louis M. Kwong, MD, A. John Miller, MD, and Philipp Lubinus, MD

A Modular Distal Fixation Option for Proximal Bone Loss in Revision Total Hip Arthroplasty, A 2- to 6- Year Follow-up Study, The Journal of Arthroplasty Vol.18 No. 3 Suppl.1 March 2003 ([H122](#))

Daniel J. Berry, MD

Treatment of Vancouver B3 Periprosthetic Femur Fractures With a Fluted Tapered Stem, Clinical Orthopaedics, No. 417, December 2003, pp. 224-231 ([H128](#))

W. Klauser, P. Lubinus

MP-Rekonstruktionsprothese (LINK), Modulare Revisionsendoprothetik des Hüftgelenks, Sonderdruck aus P. Thümler, R. Forst /Hrsg), Seiten 264-270, Springer-Verlag Berlin Heidelberg, 2004 ([H130](#))

Stephen B. Murphy, MD, and Jose Rodriguez, MD

Revision Total Hip Arthroplasty With Proximal Bone Loss, The Journal of Arthroplasty Vol.19; No. 4; Suppl 1; June 2004 ([H133](#))

Scott M. Sporer, MD, MS; Wayne G. Paprovsky, MD, FACS

Femoral Fixation in the Face of Considerable Bone Loss, Clinical Orthopaedics, No. 429, pp 227-231, 2004

Clinical Cases with the LINK MP Hip System

Order No.: 664So/4.99L

G.S. Tamvakopoulos, C.T.J. Servant, G. Clark, J.P. Ivory

Medium-term follow-up series using a modular distal fixation prosthesis to address proximal femoral bone deficiency in revision total hip arthroplasty. A 5- to 9-years follow-up study, Hip International Vol.17 no. 3; 2007 - pp. 143-149 ([H152](#))

J.A. Rodriguez MD, R. Fada MD, S.B. Murphy MD, V.J. Rasquinha MD, C.S. Ranawat MD

Two-Year to Five-Year Follow-Up of Femoral Defects in Femoral Revision Treated with the Link MP Modular Stem, The Journal of Arthroplasty Vol.24 no. 5; August 2009 ([H156](#))

R.J. Weiss, F. Strömwall, M.O. Beckmann, K.A. Hansson, A. Stark

Distal femoral stem-bone anchorage of a cementless revision total hip arthroplasty Acta Orthopaedica 80 (3): 298-302; 2009 ([H160](#))

M.D. Schofer, T. Efe, T.J. Heyse, N. Timmesfeld, R. Velte, F. Hinrichs, J. Schmitt

Zementfreier Femurschaftwechsel mit einem modularen Hüftendoprothesenrekonstruktionsschaft Der Orthopäde, Bd 39, Heft 2: Februar 2010 ([H162](#))

R.J. Weiss MD PhD, M.O. Beckmann MD, † A. Enocson MD, ‡ A. Schmalholz MD PhD, ‡ A. Starck MD PhD

Minimum 5-Year Follow-Up of a Cementless, Modular, Tapered Stem in Hip Revision Arthroplasty The Journal of Arthroplasty, Vol. 26, No. 1; 2011 ([H169](#))

R.R. Thakur MD, A.J. Deshmukh MD, A.Goyal MD, A.S. Ranawat MD, V.J. Rasquinha MD, J.A. Rodriguez MD

Management of Failed Trochanteric Fracture Fixation With Cementless Modular Hip Arthroplasty Using a Distally Fixing Stem, The Journal of Arthroplasty, Vol. 26, No. 3; 2011 ([H170](#))

W. Klauser MD, Y. Bangert MD, P. Lubinus MD, † D. Kendoff MD

Medium-Term Follow-Up of a Modular Tapered Noncemented Titanium Stem in Revision Total Hip Arthroplasty: A Single-Surgeon Experience , The Journal of Arthroplasty, In Press, Corr. Proof, Av. online 19 Oct 2012 ([H174](#))

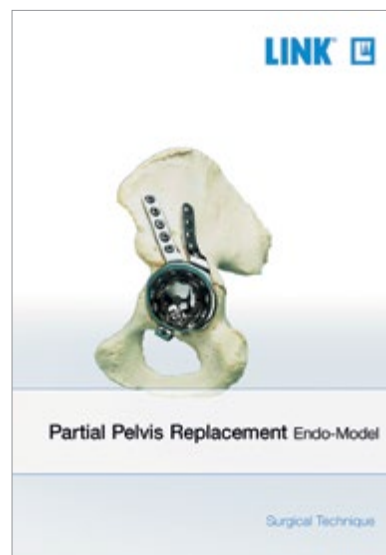

 For more information please register for our LINK Media Library (link-ortho.com)

MP Reconstruction System
General indication
Mobility-limiting diseases, fractures or defects of the hip joint or proximal femur which cannot be treated by conservative or osteosynthetic procedures
Indications
The prosthesis is used when fixation is required below the level of the femoral metaphysis in hip arthroplasty
Contraindications
Insufficient / inadequate bone mass- or quality which prevents a stable anchorage of the prosthesis.
Poor general state of health
Acute and chronic infections, local and systemic, insofar as they may compromise the successful implantation
Allergies to (implant) materials

**The MP Reconstruction System is for cementless use.
Only cemented labeled modular stems are indicated for cemented use.**

INFORMATION:

The above indications and contraindications are based on standard cases. The final decision regarding an implant must be made by the surgeon for each patient on the basis of the surgeon's individual analysis and experience.

Please note the following regarding the use of our implants:

1. Choosing the right implant is very important.

The size and shape of the human bone determines the size and shape of the implant and also limits the load capacity. Implants are not designed to withstand unlimited physical stress. Demands should not exceed normal functional loads.

2. Correct handling of the implant is very important.

Under no circumstances should the shape of a finished implant be altered, as this shortens its life span. Our implants must not be combined with implants from other manufacturers. The instruments indicated in the Surgical Technique must be used to ensure safe implantation of the components.

3. Implants must not be reused.

Implants are supplied sterile and are intended for single use only. Used implants must not be used again.

4. After-treatment is also very important.

The patient must be informed of the limitations of the implant. The load capacity of an implant cannot compare with that of healthy bone!

5. Unless otherwise indicated, implants are supplied in sterile packaging.

Note the following conditions for storage of packaged implants:

- Avoid extreme or sudden changes in temperature.
- Sterile implants in their original, intact protective packaging may be stored in permanent buildings up until the "Use by" date indicated on the packaging.
- They must not be exposed to frost, dampness or direct sunlight, or mechanical damage.
- Implants may be stored in their original packaging for up to 5 years after the date of manufacture. The "Use by" date is indicated on the product label.
- Do not use an implant if the packaging is damaged.

6. Traceability is important.

Please use the documentation stickers provided to ensure traceability.

7. Further information on the material composition is available on request from the manufacturer.

Follow the instructions for use!

Waldemar Link GmbH & Co. KG, Hamburg

All content in this catalog, including text, pictures and data, is protected by law. Every instance of use, whether in part or in whole and which is not permitted by law, is subject to our prior consent. In particular, this applies to the reproduction, editing, translation, publishing, saving, processing, or passing on of content stored in databases or other electronic media and systems, in any manner or form. The information in the catalogs is solely intended to describe the products and does not constitute a guarantee.

The Surgical Technique described has been written to the best of our knowledge and belief, but it does not relieve the surgeon of his/her responsibility to duly consider the particularities of each individual case.

Products shown in this document may not be available in your country. The product availability is subject to the approval and/or registration regulations of the respective country. Please contact Waldemar Link GmbH & Co. KG if you have questions about the availability of LINK products in your country.

Waldemar Link GmbH & Co. KG and/or other corporate affiliated entities own, use or have applied for the following trademarks in many jurisdictions: LINK, BiMobile, SP II, Modell Lubinus, E-Dur, EndoDur, T.O.P. II, BetaCup, CombiCup PF, CombiCup SC, CombiCup R, MobileLink, C.F.P., LCU, SP-CL, LCP, MIT-H, Endo-Model, Endo-Model SL, MP, MEGASYSTEM-C, GEMINI SL, SPAR-K, LCK, Link OptiStem, HX, TiCaP, X-LINKed, PorAg, LINK PorEx, BiPorEx, PorEx-Z, TrabecuLink, Tilastan, customLINK, RescueSleeve, Stactip, VACUCAST.

Other trademarks and trade names may be used in this document to refer to either the entities claiming the marks and/or names or their products and are the property of their respective owners.

 Waldemar Link GmbH & Co. KG

Barkhausenweg 10 · 22339 Hamburg · Germany
Phone +49 40 53995-0 · info@link-ortho.com
www.link-ortho.com

