





## SII Model Lubinus Hip Stem

Anatomically Adapted Cemented Long Stem Prosthesis

## CE 0482

Explanation of Pictograms			
	Manufacturer		Article number
	Material number		Product meets the applicable requirements, which are regulated in the EU harmonization legislation for the affixing of the CE marking.

# SPII Model Lubinus Hip Stem

## Anatomically Adapted Cemented Long Stem Prosthesis

### **Description**

02 System Description

### **Surgical Technique**

03 Preoperative Planning

04 Surgical Approaches

05 Surgical Technique

### **Implants**

10 SPII Model Lubinus Long Stem Prosthesis Standard Neck

12 SPII Model Lubinus Long Stem Prosthesis XL Neck

### **Instruments**

16 Instruments for SPII Model Lubinus Long Stem Prosthesis

17 Coupling of the Rasp

19 Additional Instruments for Hip Implantation

### **Accessories - Literature**

22 X-ray Templates

22 Instructions for Cleaning and Maintenance

22 Literature

24 **Indications/Contraindications**

### **Important Information**

## System Description

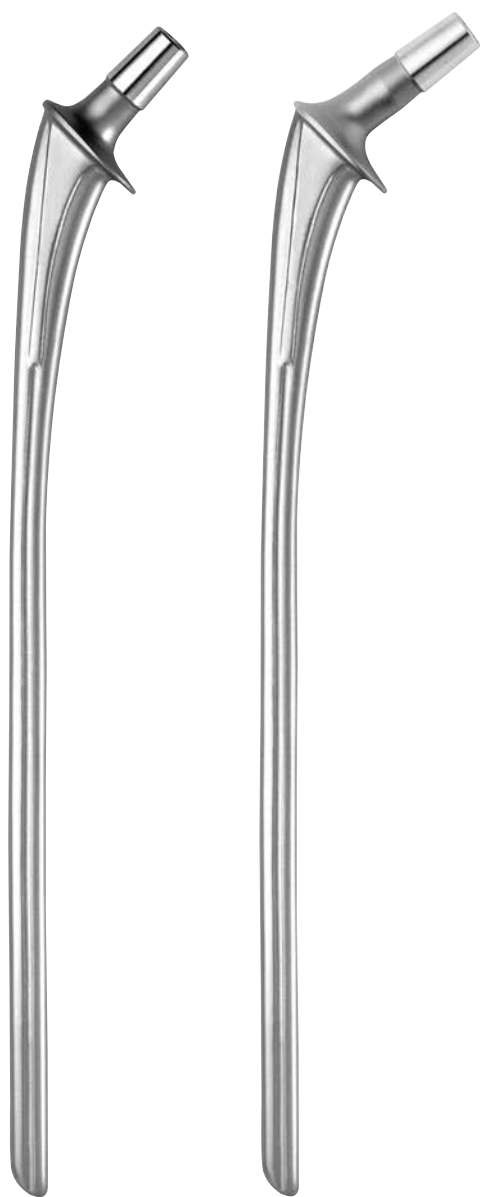

The number of primary hip prostheses implanted each year throughout the world continues to grow. Alongside these primary replacements, the number of revision operations is increasing at rates in the order of double-figure percentages. It is clear that both the number and the complexity of revision operations will grow strongly in the short and medium term.

A range of cementable revision hip prosthesis stems is available for this group of patients. They differ markedly from primary hip prostheses in their design and function and in the surgical techniques used for their implantation. These differences often call for an individual approach when identifying indications, planning the operation, choosing surgical techniques and, caring for patients after surgery.

### **SPII Model Lubinus Long Stem Prosthesis**

**Standard Neck** with a 12/14 mm taper are available as right-sided and left-sided versions (anatomical design) with stem lengths of 200–350 mm and 3 different stem thicknesses (medium to extra large) with CCD angles of 126° and 135°.

### **SPII Model Lubinus Long Stem Prostheses XL**

**Neck** are available in three thicknesses (medium to extra large). The neck lengths are 10 mm longer than those of the standard neck type.

## Preoperative Planning

Measurement tables and X-ray templates are available to aid preoperative planning of hip stem revision.

They allow the surgeon to plan precisely which implants are to be used.

Exact preoperative planning is based on X-ray images which are either true to scale or supplied with precise details of the enlargement factor employed. LINK X-ray templates use a standard enlargement factor of 110% when depicting implants. If different scales are required we can supply them as long as this is technically possible. On request we can provide producers of digital planning software with the relevant data in standard formats.

In spite of good preoperative planning, revision cases frequently involve extensive bone loss. This presents an unforeseeable challenge to surgeons that is rarely encountered in primary hip replacement. The procedures used to compensate for this bone loss vary greatly depending on the individual situation. Where tumor prostheses are involved, structural changes in muscles/ligaments, fixation, etc. also need to be taken into account when planning surgery. As a result, the treatment of patients with extensive bone loss represents a special problem and subject to greater risk than is the implantation of normal hip prostheses.

## Surgical Approaches

The choice of approach depends on the surgeon's experience and their decision based on the individual situation.

The following approaches are usual:

- antero-lateral - **Watson-Jones** (Fig. A)
- direct lateral - **Hardinge** (Fig. B)
- postero-lateral - **Moore** (Fig. C)

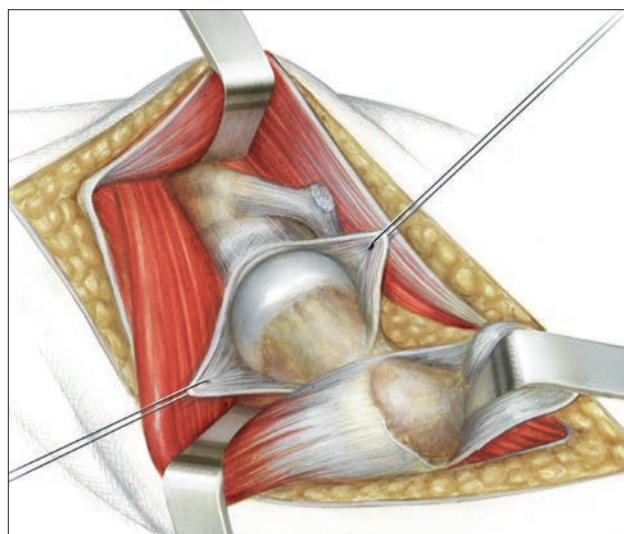

Fig. A: **Watson-Jones**

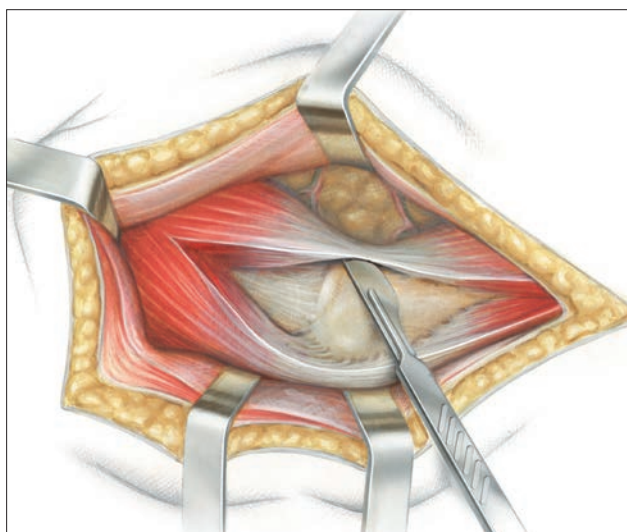

Fig. B: **Hardinge**

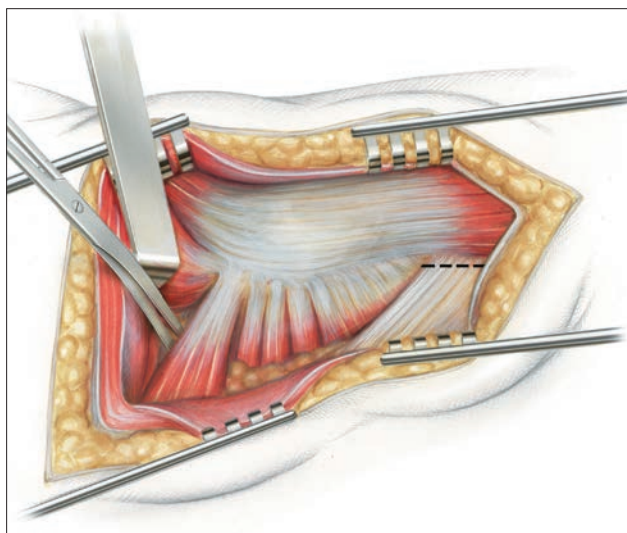
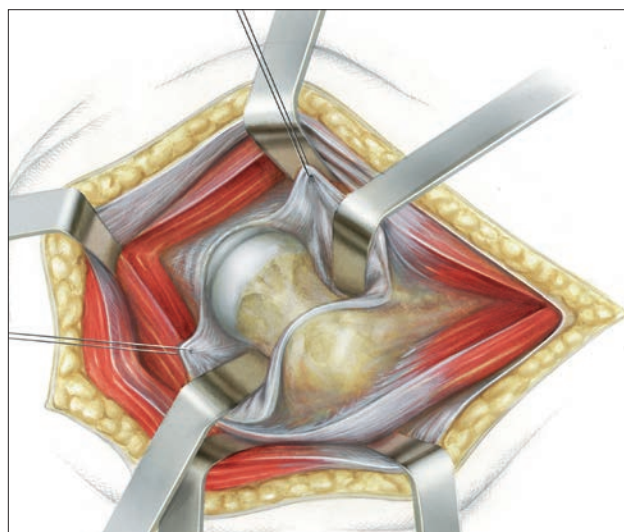
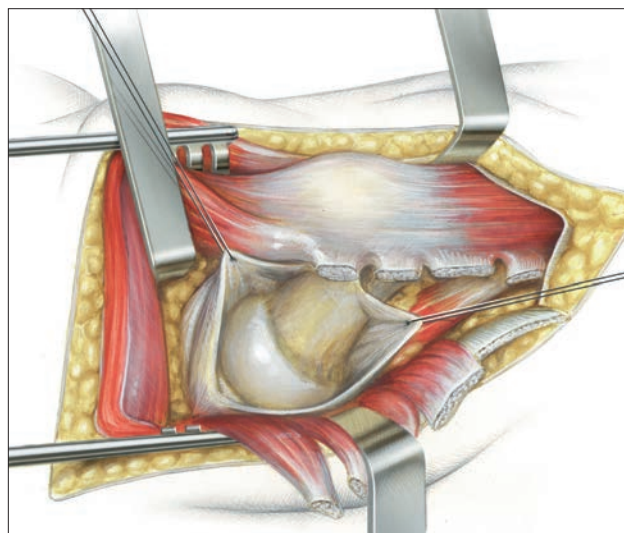

Fig. C: **Moore**



## Surgical Technique

Any implants in situ must be completely removed before a revision stem can be implanted. This can be performed either with specific instruments for the implant system being removed or with general revision instruments. Any bone cement residues must be completely removed.



Fig. 1

Fig. 1

The femoral canal is opened with the Femoral Canal Opener and bone is removed from the greater trochanteric region. The presence of this bone will be largely dependent on the stem previously implanted and the stem removal process. Use the Femoral Canal Opener to remove lateral bone as shown. Removing lateral bone is important to maintain neutral stem placement relative to the femoral axis.

The medullary canal has to be prepared with a reamer of corresponding length. To ensure consistent cement application, the diameter of the reamer must be larger than the tip of the prosthesis.



Fig. 2

Fig. 2

Flexible reamers are used to widen the diaphysis. The diameters of the femoral reamers must be at least 2 mm greater than the distal tip of the chosen SP11 Long Stem Prosthesis. Starting with one size smaller than the planned hip stem, the reamer size must be incrementally increased until it is equal to the planned hip stem.



Fig. 3



Fig. 4

Fig. 3

The Rasp Stem is inserted with a coupled Universal Handle.

Due to the anatomical shape of the rasps, the anteversion usually adjusts itself automatically when they are driven in. The femoral canal is prepared with rasps of increasing size until the planned size is reached.

**INFORMATION:**

To widen the proximal lateral part, the rasp can be run up and down a couple of times. This creates more space for the cement in this area.

The size of the rasp corresponds roughly to that of the implants (rasp is 0.75 mm larger than the implant). To create a cement mantle of about 2–3 mm, the implanted stem needs to be one size smaller than the last rasp used (e.g., rasp stem R3 = prosthesis stem R2).

Fig. 4

The rasp is then left in situ. The rasp stem sits slightly lower than the lowest point of the resection level.



Fig. 5

Fig. 5

The Calcar Reamer is now used to create a plane parallel seat on the proximal femur to allow precise seating of the collar.

**CAUTION:**

To prevent the reamer from being damaged, it must be pushed as far as possible caudally onto the guide pin before starting to ream.



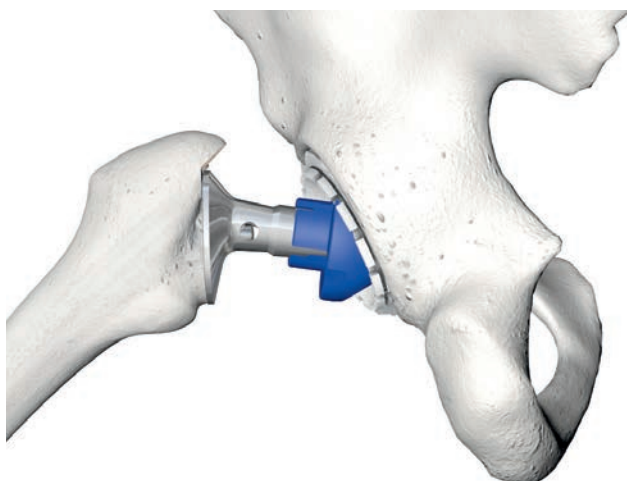

Fig. 6

Trial reduction is carried out with the final size of rasp in situ. The handle is removed and the Trial Neck Segment selected in preoperative planning (right/left, CCD angle) is placed on the rasp. The different Trial Heads are then used to check for optimal offset and correct leg length and to test whether the stability is adequate. The range of movement is also checked to avoid impingement of bone and implant and rule out any instability.

Fig. 6

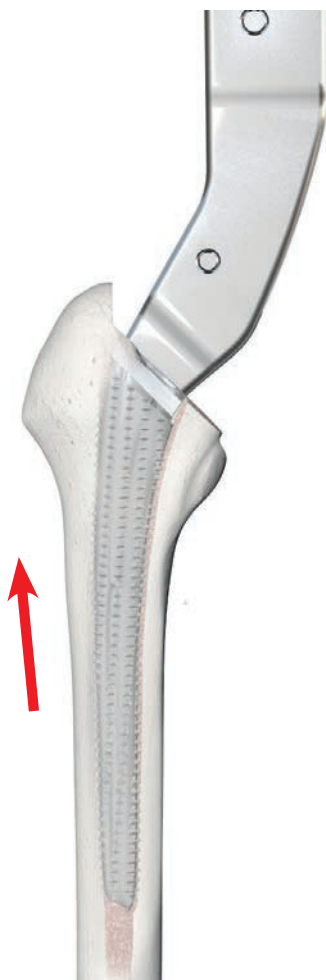

Fig. 7

After trial reduction, the Trial Head and Neck are removed by hand and the rasp is removed with the rasp handle.

Fig. 7



**Fig. 8**

After removing the rasp, the femoral canal is rinsed thoroughly. Jet lavage is recommended for this. The medullary space is blocked a few centimeters below the planned position of the tip of the femoral stem using an Intramedullary Plug. For more information, please see the separate Surgical Technique “Intramedullary Plugs.”

**Fig. 9**

The cement is mixed under vacuum and then inserted into the femoral canal using an applicator syringe with a nozzle. Application begins distally. The canal is filled with cement retrogradely and uniformly by slowly withdrawing the nozzle as the cement is being applied. The cement is then compressed in the femoral canal for approx. 30 seconds using a cement compressor.

**Fig. 10**

After cement application, the SPII Model Lubinus Long Stem is introduced into the femoral cavity as far as possible using the Insertion Forceps.



**Fig. 8**

**Fig. 9**

**Fig. 10**

**INFORMATION:**

Before filling the femoral canal, check the viscosity of the cement by touching the cement on the tip of the applicator syringe with your finger while wearing clean gloves. The best time to apply the cement is when it adheres well to the glove and is drawn out in long, heavy threads.

**CAUTION:**

The SPII Model Lubinus Hip Stem provides integrated anatomical antetorsion. Do not further correct the anteversion as is done with straight stems.



Fig. 11

Fig. 11

The SPII Model Lubinus Long Stem Prosthesis is driven into its final position using the Impactor. Surplus cement must be removed. While the cement cures, the stem is pressed firmly into the cement bed with the tip of the Impactor positioned in the hemispherical depression at the lateral collar, which prevents transmitting the surgeon's movements to the stem.

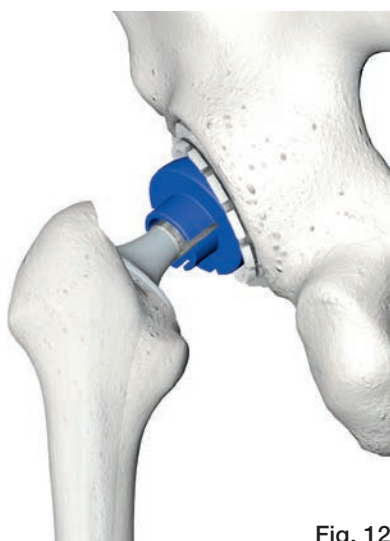

Fig. 12

To be on the safe side, a final trial run is performed using the colored plastic Trial Heads.

Fig. 12

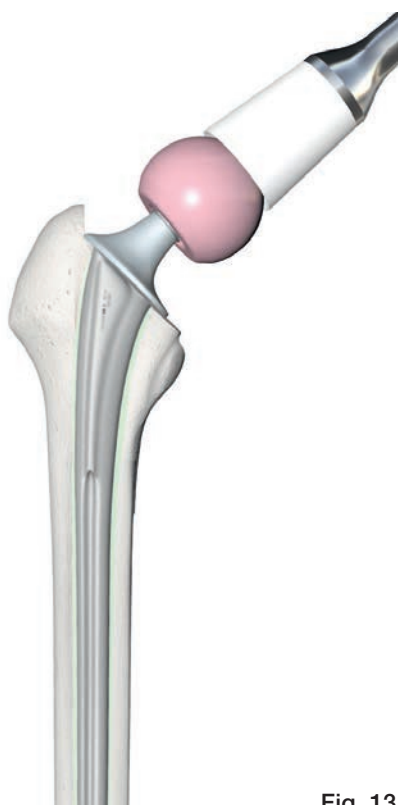

Fig. 13

The definitive Femoral Head is placed on the carefully cleaned taper of the stem and fixed by lightly tapping the Impactor.

**Removing the components**

Each of the prosthesis components can be removed if necessary.

The Prosthesis Head can be removed in an axial direction using a rod that is placed at the base of the head.

The femoral component can be removed by tapping the stem out of the cement mantle using general hip stem extraction and revision instruments.

**CAUTION:**

If a ceramic head has to be replaced with another ceramic head, only use ceramic revision heads (with a metal inner taper).

Fig. 13

**SPII Model Lubinus Long Stem Prosthesis Standard Neck**

**MAT** EndoDur (CoCrMo alloy), taper 12/14 mm

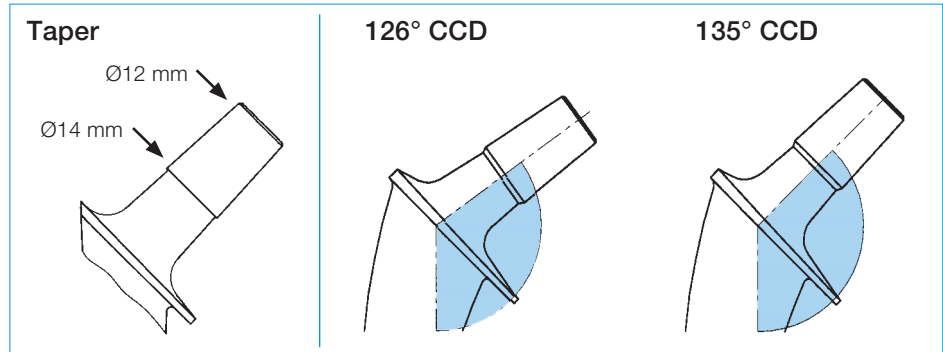

- R = right
- L = left
- 2 = medium
- 3 = large
- 4 = extra large

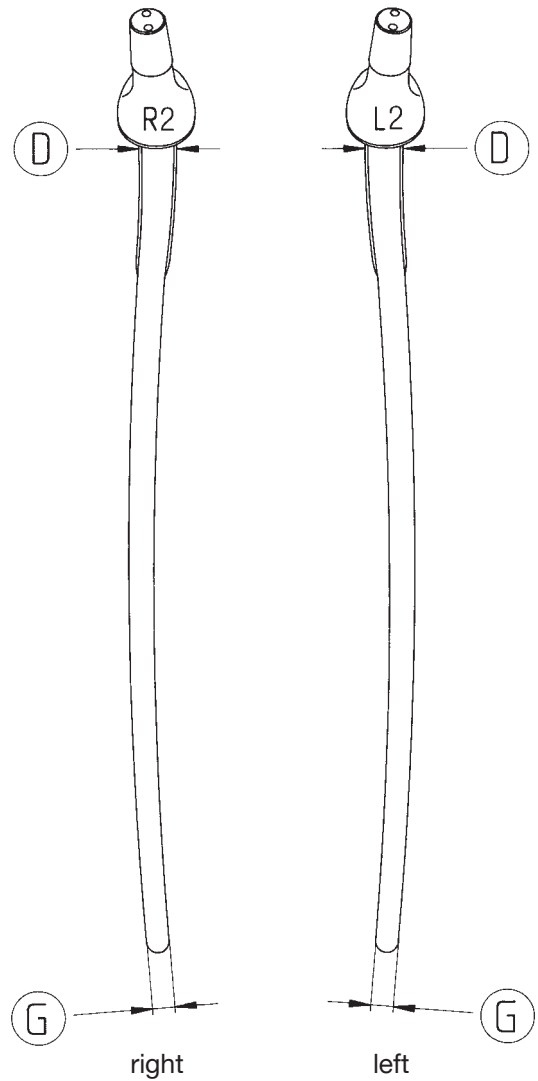
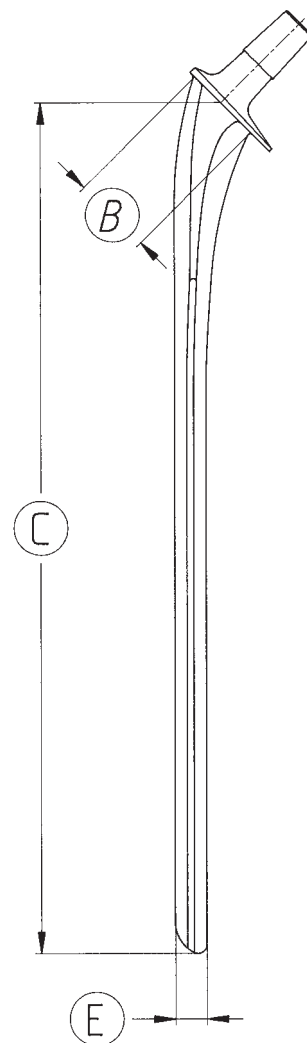

### SPII Model Lubinus Long Stem Prosthesis Standard Neck

**MAT** EndoDur (CoCrMo alloy), taper 12/14 mm

CCD- $\angle$ 126° <b>REF</b>	CCD- $\angle$ 135° <b>REF</b>	Stem width	ⓑ mm	ⓒ mm	ⓓ mm	ⓔ mm	ⓖ mm	
Version right								
127-910/26	127-910/35	R 2	27.5	350	14	11	8	medium
127-912/26	127-912/35	R 3	29.5	350	15	12	9	large
127-914/26	127-914/35	R 4	31.5	350	16	13	10	extra large
127-916/26	127-916/35	R 2	27.5	300	14	11	8	medium
127-918/26	127-918/35	R 3	29.5	300	15	12	9	large
127-920/26	127-920/35	R 4	31.5	300	16	13	10	extra large
127-922/26	127-922/35	R 2	27.5	250	14	11	8	medium
127-924/26	127-924/35	R 3	29.5	250	15	12	9	large
127-926/26	127-926/35	R 4	31.5	250	16	13	10	extra large
127-928/26	127-928/35	R 2	27.5	200	14	11	8	medium
127-930/26	127-930/35	R 3	29.5	200	15	12	9	large
127-932/26	127-932/35	R 4	31.5	200	16	13	10	extra large
Version left								
127-911/26	127-911/35	L 2	27.5	350	14	11	8	medium
127-913/26	127-913/35	L 3	29.5	350	15	12	9	large
127-915/26	127-915/35	L 4	31.5	350	16	13	10	extra large
127-917/26	127-917/35	L 2	27.5	300	14	11	8	medium
127-919/26	127-919/35	L 3	29.5	300	15	12	9	large
127-921/26	127-921/35	L 4	31.5	300	16	13	10	extra large
127-923/26	127-923/35	L 2	27.5	250	14	11	8	medium
127-925/26	127-925/35	L 3	29.5	250	15	12	9	large
127-927/26	127-927/35	L 4	31.5	250	16	13	10	extra large
127-929/26	127-929/35	L 2	27.5	200	14	11	8	medium
127-931/26	127-931/35	L 3	29.5	200	15	12	9	large
127-933/26	127-933/35	L 4	31.5	200	16	13	10	extra large

**SPII Model Lubinus Long Stem Prosthesis XL Neck**

**MAT** EndoDur (CoCrMo alloy), taper 12/14 mm

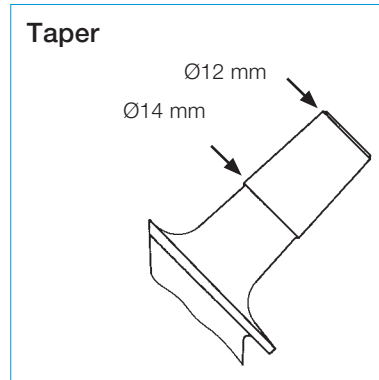

Each stems bears an identification mark on the top of the collar consisting of one letter and one number:

- R = right
- L = left
- 2 = medium
- 3 = large
- 4 = extra large

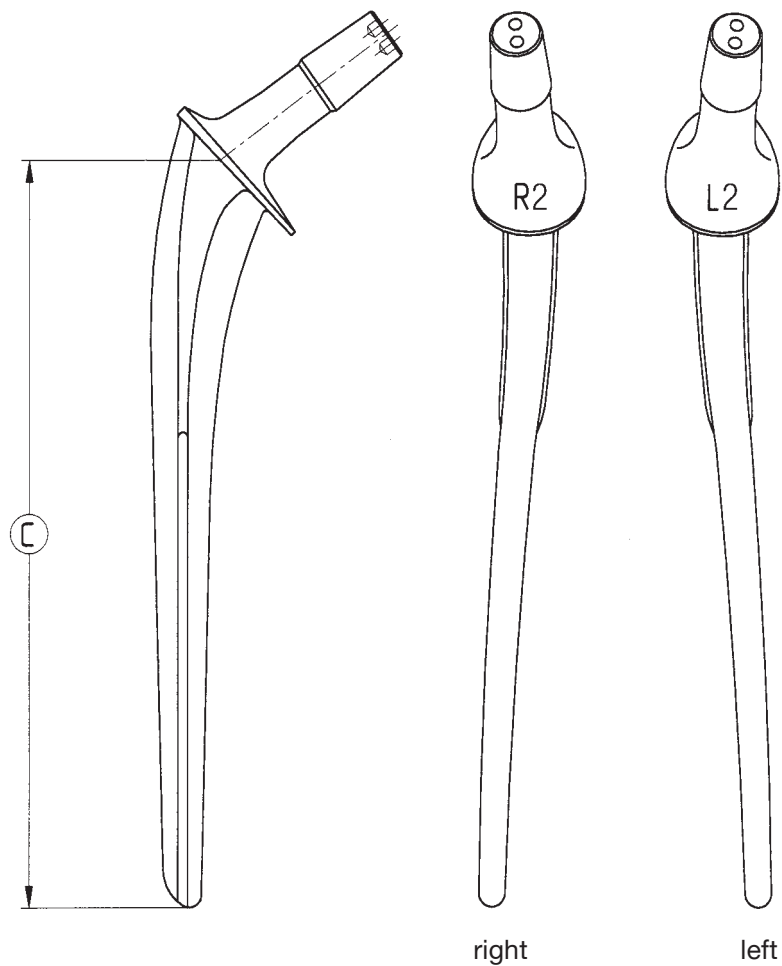

**SPII Model Lubinus Long Stem Prosthesis XL Neck**

**MAT** EndoDur (CoCrMo alloy), taper 12/14 mm

CCD $\nabla$ 126°	CCD $\nabla$ 135°			
<b>REF</b>	<b>REF</b>	Stem length © mm	Stem width	
<b>Version right</b>				
127-940/26	127-940/35	350	R2	medium
127-942/26	127-942/35	350	R3	large
127-944/26	127-944/35	350	R4	extra large
127-946/26	127-946/35	300	R2	medium
127-948/26	127-948/35	300	R3	large
127-950/26	127-950/35	300	R4	extra large
127-952/26	127-952/35	250	R2	medium
127-954/26	127-954/35	250	R3	large
127-956/26	127-956/35	250	R4	extra large
127-958/26	127-958/35	200	R2	medium
127-960/26	127-960/35	200	R3	large
127-962/26	127-962/35	200	R4	extra large
<b>Version left</b>				
127-941/26	127-941/35	350	L2	medium
127-943/26	127-943/35	350	L3	large
127-945/26	127-945/35	350	L4	extra large
127-947/26	127-947/35	300	L2	medium
127-949/26	127-949/35	300	L3	large
127-951/26	127-951/35	300	L4	extra large
127-953/26	127-953/35	250	L2	medium
127-955/26	127-955/35	250	L3	large
127-957/26	127-957/35	250	L4	extra large
127-959/26	127-959/35	200	L2	medium
127-961/26	127-961/35	200	L3	large
127-963/26	127-963/35	200	L4	extra large

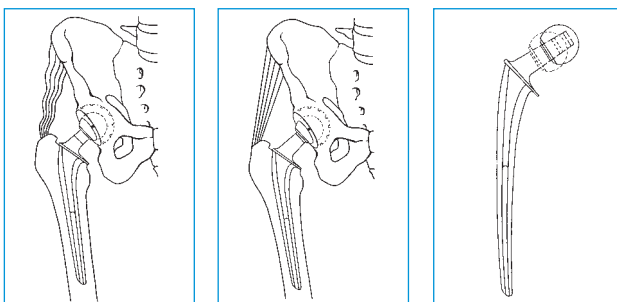

The neck section/taper of SII Model Lubinus Hip Stem XL neck types is 10.5 mm longer than the standard neck types.

When combined with standard prosthesis heads, they result in increased head-neck lengths.

The XL neck types are intended for use in cases where anatomically correct lateralization of the femur cannot be achieved with the standard neck type of the SII Model Lubinus Hip Stem.

**INFORMATION:**

SII Model Lubinus Long Stem Prosthesis XL Neck can be combined with prosthesis heads with up to +4 mm additional neck length.

[For more information, refer to the SII Model Lubinus Hip Stem catalog.](#)

Instruments for SPII Model Lubinus Long Stem Prosthesis

Basic tray



Rasp trays R & L



REF	Description
130-100/15	Basic Instrument Set, complete
130-170/10	Rasp Stem Set, 170 mm

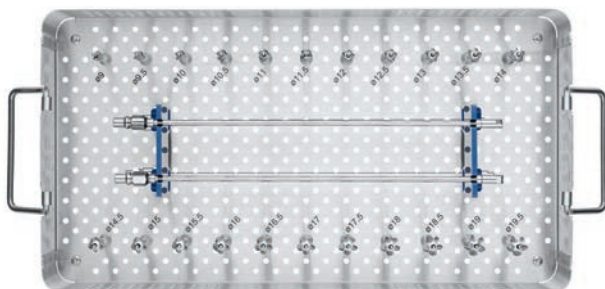

130-250/00 Femoral Reamer Set



130-100/15 Basic Instrument Set

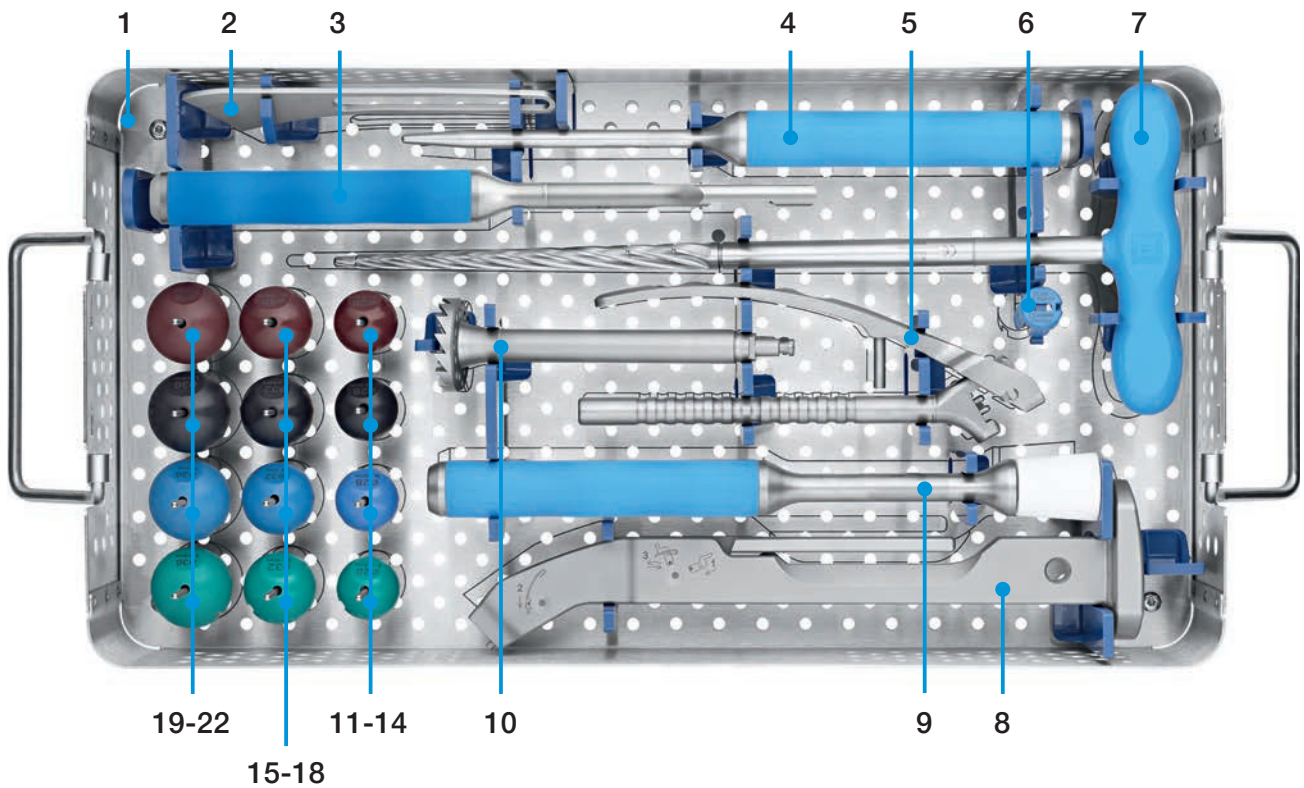

	REF	Description
1	130-100/10	<b>Instrument Tray</b> , empty
2	130-614	<b>Resection Guide</b> , 160 mm
3	130-616	<b>Box Chisel</b> , 290 mm
4	130-613	<b>Impactor</b> , 296 mm
5	131-830/03	<b>Inserting Forceps</b> , 200 mm
6	131-830/04	<b>Taper Cap</b> , exchangeable
7	130-617	<b>Femoral Canal Opener</b> , 365 mm
8	130-394/01	<b>Universal Handle</b> with quick coupling, straight
9	130-610/01	<b>Impactor</b> , with exchangeable plastic head, 280 mm
10	130-407/02B	<b>Calcar Reamer</b> with CoCr inner cylinder, <b>Hudson Fitting</b> , Ø 40 mm, 150 mm
		Adapter, optional:
	130-407/02D	<b>Calcar Reamer</b> with CoCr inner cylinder, <b>AO Fitting</b> , Ø 40 mm, 150 mm
11	175-928/14	<b>Trial Head</b> , Radiopaque, PPSU, brown, Ø 28 mm, Taper 12/14 mm, Neck L= XL / + 10.5 mm
12	175-928/13	<b>Trial Head</b> , Radiopaque, PPSU, black, Ø 28 mm, Taper 12/14 mm, Neck L= L / + 3.5 mm
13	175-928/12	<b>Trial Head</b> , Radiopaque, PPSU, blue, Ø 28 mm, Taper 12/14 mm, Neck L= M / + 0 mm
14	175-928/11	<b>Trial Head</b> , Radiopaque, PPSU, green, Ø 28 mm, Taper 12/14 mm, Neck L= S / - 3.5 mm
15	175-932/14	<b>Trial Head</b> , Radiopaque, PPSU, brown, Ø 32 mm, Taper 12/14 mm, Neck L= XL / + 8.5 mm
16	175-932/13	<b>Trial Head</b> , Radiopaque, PPSU, black, Ø 32 mm, Taper 12/14 mm, Neck L= L / + 4 mm
17	175-932/12	<b>Trial Head</b> , Radiopaque, PPSU, blue, Ø 32 mm, Taper 12/14 mm, Neck L= M / 0 mm
18	175-932/11	<b>Trial Head</b> , Radiopaque, PPSU, green, Ø 32 mm, Taper 12/14 mm, Neck L= S / - 4 mm
19	175-936/14	<b>Trial Head</b> , Radiopaque, PPSU, brown, Ø 36 mm, Taper 12/14 mm, Neck L= XL / + 8 mm
20	175-936/13	<b>Trial Head</b> , Radiopaque, PPSU, black, Ø 36 mm, Taper 12/14 mm, Neck L= L / + 4 mm
21	175-936/12	<b>Trial Head</b> , Radiopaque, PPSU, blue, Ø 36 mm, Taper 12/14 mm, Neck L= M / 0 mm
22	175-936/11	<b>Trial Head</b> , Radiopaque, PPSU, green, Ø 36 mm, Taper 12/14 mm, Neck L= S / - 4 mm

130-170/11 Rasp Stem Sets

LEFT

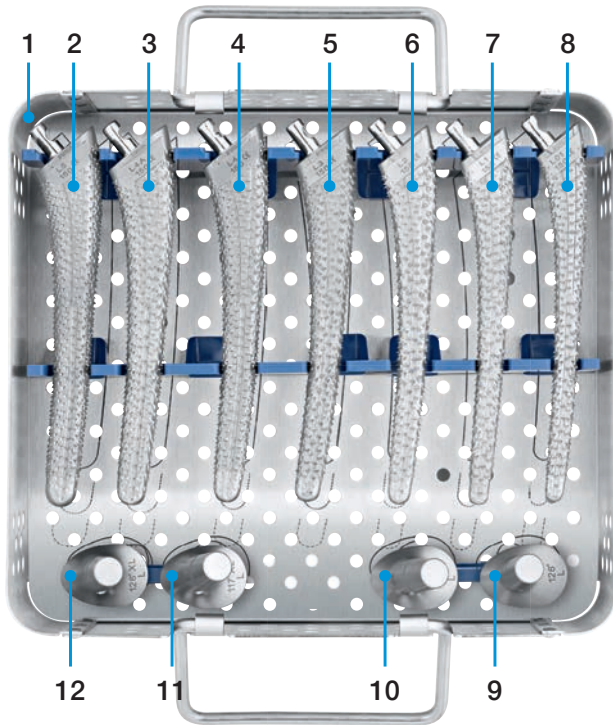

RIGHT

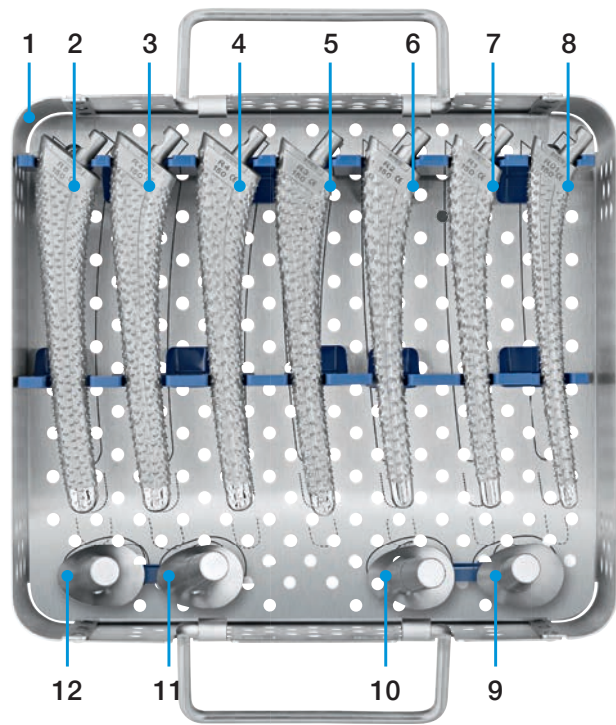

	REF	Description
1	130-100/30	Instrument Tray, empty
2	130-555/07	Rasp Stem, 170 mm, left
3	130-555/06	Rasp Stem, 170 mm, left
4	130-555/05	Rasp stem, 170 mm, left
5	130-555/04	Rasp Stem, 170 mm, left
6	130-555/03	Rasp Stem, 170 mm, left
7	130-555/02	Rasp Stem, 170 mm, left
8	130-555/01	Rasp Stem, 170 mm, left
9	131-531/26	Trial Neck Segment, 126°
10	131-531/35	Trial Neck Segment, 135°
11	131-529/26	Trial Neck Segment, 126°, XL
12	131-529/35	Trial Neck Segment, 135°, XL

	REF	Description
1	130-100/20	Instrument Tray, empty
2	130-554/07	Rasp Stem, 170 mm, right
3	130-554/06	Rasp Stem, 170 mm, right
4	130-554/05	Rasp Stem, 170 mm, right
5	130-554/04	Rasp Stem, 170 mm, right
6	130-554/03	Rasp Stem, 170 mm, right
7	130-554/02	Rasp Stem, 170 mm, right
8	130-554/01	Rasp Stem, 170 mm, right
9	131-530/26	Trial Neck Segment, 126°
10	131-530/35	Trial Neck Segment, 135°
11	131-528/26	Trial Neck Segment, 126°, XL
12	131-528/35	Trial Neck Segment, 135°, XL

### Coupling of the rasp



**1**  
To couple rasp and handle, the catch is retracted fully (arrow, left). The rasp fitting is then inserted into the mount on the front of the handle (arrow, right).



**2**  
To secure the connection between rasp and handle, the catch is pushed forward (arrow).



**3**  
To disengage, open the handle (arrow). The handle can then be detached from the rasp.

### Instruments



Colored Plastic Trial Heads, Taper 12/14 mm

REF	Ø (mm)	Head length	Head length (mm)	Color	Qty
175-940/11	40	short	-4.0	green	1
175-940/12	40	medium	0.0	blue	1
175-940/13	40	long	+4.0	black	1
175-940/14	40	extra long	+8.0	brown	1

130-250/00 Femoral Reamer Set

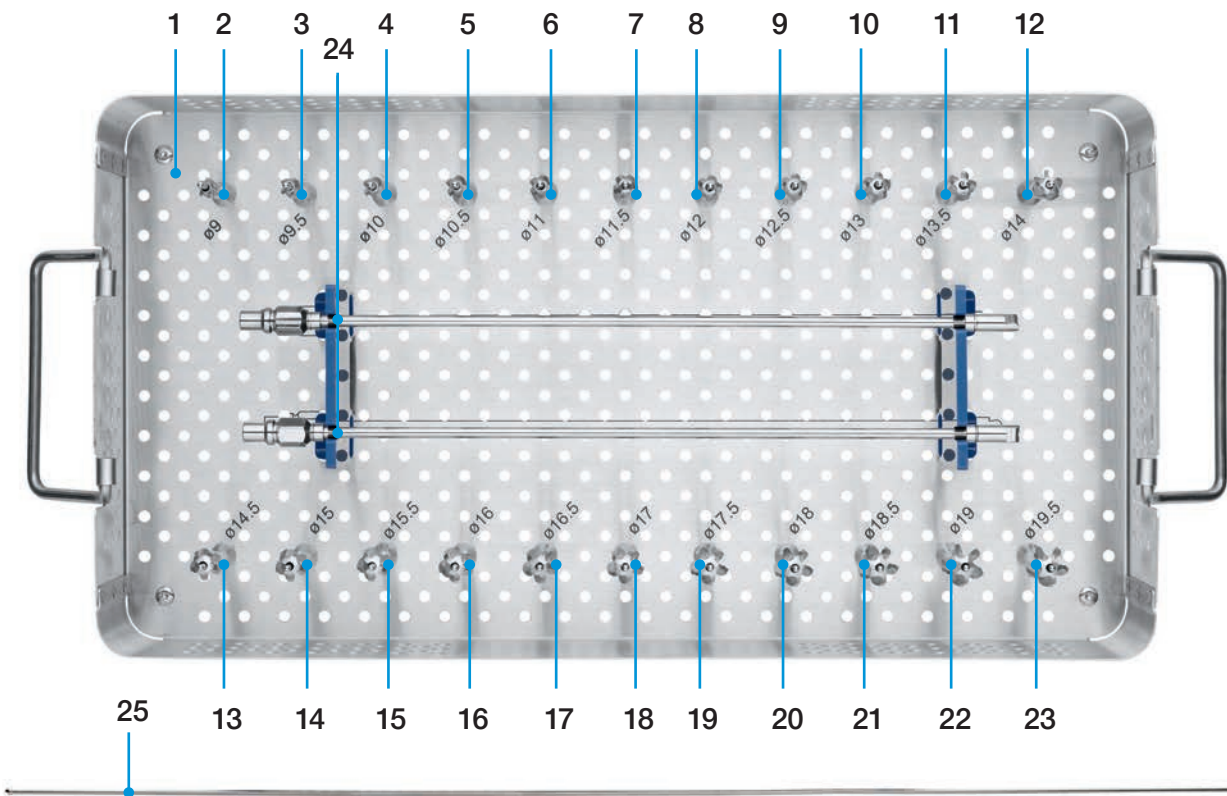

	REF	Description	Ø (mm)
1	130-251/00	Instrument Tray, empty	
2	130-370/01	Reamer Head	9.0
3	130-370/02	Reamer Head	9.5
4	130-370/03	Reamer Head	10.0
5	130-370/04	Reamer Head	10.5
6	130-370/05	Reamer Head	11.0
7	130-370/06	Reamer Head	11.5
8	130-370/07	Reamer Head	12.0
9	130-370/08	Reamer Head	12.5
10	130-370/09	Reamer Head	13.0
11	130-370/10	Reamer Head	13.5
12	130-370/11	Reamer Head	14.0
13	130-370/12	Reamer Head	14.5
14	130-370/13	Reamer Head	15.0
15	130-370/14	Reamer Head	15.5
16	130-370/15	Reamer Head	16.0
17	130-370/16	Reamer Head	16.5
18	130-370/17	Reamer Head	17.0
19	130-370/18	Reamer Head	17.5
20	130-370/19	Reamer Head	18.0
21	130-370/20	Reamer Head	18.5
22	130-370/21	Reamer Head	19.0
23	130-370/22	Reamer Head	19.5
24	130-376B	Flexible Reamer Shaft, Length 350 mm, 2 pcs	
25	130-376/01	Guide Wire, Length 670 mm, Ø 3.0 mm	

### Additional Instruments for Hip Implantation

**Dederich Bone Retractor** with hollow handle  
 The design makes it possible to hold the instrument comfortably for long periods.

REF	Version	Width	Length
15-1032	medium	18 mm	150 mm
15-1033	wide	43 mm	195 mm



**Soft Tissue Retractors**  
 with retrograde curved

REF	Version	Width	Length
66-3470	small	22 mm	325 mm
66-3472	wide	43 mm	325 mm



**Hohmann Retractor**

REF	Version	Width	Length
130-100	small	10 mm	240 mm
130-105	medium	22 mm	260 mm
130-110	wide	43 mm	240 mm

**Additional Instruments for Hip Implantation**

**130-114 Bone Retractor** with fenestrated handle  
30 mm wide, 260 mm long



**130-120 Bone Hook**  
single prong, with T-handle, 210 mm



**68-1475 Cartilage Clamp**  
with toothed jaws, 200 mm



**50-2562 Cartilage Scissors**  
straight, 220 mm



**50-2564 Cartilage Scissors**  
curved, 220 mm



**Additional Instruments for Hip Implantation**

**Thabe Acetabulum Excision Forceps**

240 mm

REF	Version
130-309/01	straight
130-309/02	curved

This forceps is constructed like a rongeur. It has sharp cupped jaws with sharp teeth at the front. The forceps is designed to grasp coarse tissue and is particularly useful when excising the acetabular capsule.



**130-160 Lubinus Steinmann Pin**

with impact head and extraction hole  
Ø 5 mm, 185 mm

Steinmann pins are hammered into the bone to keep the incision open. One is inserted into the ischium and another is placed about 2 cm above the cranial area of the cup.



To remove them, a second pin is inserted through the hole in the head. The first pin can then be removed easily by turning.

**130-686 Slotted Driver for handle** (for rasp stems) and stem extractor  
270 mm

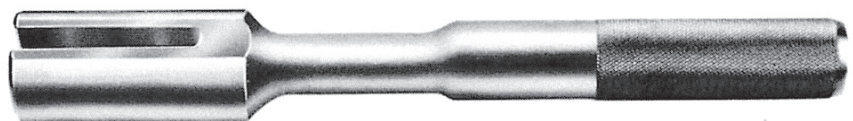

**130-165 Mallet**

Ø 30 mm, 270 mm, 600 g



**15-1078/08 Key for Jacob's Chuck**

### X-Ray Templates

#### X-Ray Templates for SPII Modell Lubinus Long Stem Prosthesis Standard Neck

Head Ø 28 mm and 32 mm, taper 12/14 mm, 110% actual size

REF	CCD angle	Head Ø mm	For stem length mm	Set of sheets
<a href="#">131-423/26</a>	126°	28/32	200, 250, 300, 350	4
<a href="#">131-423/35</a>	135°	28/32	200, 250, 300, 350	4
<a href="#">131-424/26</a>	126°	36	200, 250, 300, 350	4
<a href="#">131-424/35</a>	135°	36	200, 250, 300, 350	4

#### X-Ray Templates for SPII Modell Lubinus Long Stem Prosthesis XL Neck

Head Ø 28 mm and 32 mm, taper 12/14 mm, 110% actual size

REF	CCD angle	Head Ø mm	For stem length mm	Set of sheets
<a href="#">131-414/26</a>	126°	28/32	200, 250, 300, 350	3

### Instructions for Cleaning and Maintenance

Specific instructions for instruments are available on request: Email [info@link-ortho.com](mailto:info@link-ortho.com)

### Literature



### Additional Literature

For more information, please register for our LINK Media Library ([link-ortho.com](http://link-ortho.com))



**“Totalendoprothese des Hüftgelenks”**

H.W. Buchholz, E. Engelbrecht, J. Röttger, A. Siegel, Chir. Praxis 23, 297-306 (1977/78)

[H 16](#)

**“Einfluß eines S-förmigen Hüftschaftdesigns (Lubinus SPII) auf die femorale Spannungsverteilung”**

M. Lengsfeld, P. Alter, Th. Pressel, 1998 Orthopädie & ihre Grenzgebiete, Band 136 Heft 5 Sept./Okt., S. A50

[H 94](#)

**“Spannungsanalyse einer anatomisch adaptierten Femurschaftprothese (Lubinus SPII)”**

P. Alter, M. Lengsfeld, J. Schmitt, 1999 Orthopädie & ihre Grenzgebiete, Band 137 Nr. 2 März/April

[H 95](#)

**“Survival analysis of the cemented SPII stem”**

Annaratone, Surace, Salerno, Regis, 2000, J Orthopaed Traumatol, 1:41-45, Springer-Verlag

[H 111](#)

**“Prognosis of Total Hip Replacement”**

H. Malchau, P. Herberts et al., 2002, The Swedish National Hip Arthroplasty Register, Departement of Orthopaedics, Göteborg University, Sweden

[H 119](#)

**“Cemented total hip arthroplasty: SPII: femoral component”**

P. Lubinus, W. Klauser, B. Schwantes, R. Eberle, 2002 Giornale Italiano di Orthopedia e Traumatologia, Vol. XXVIII, Fasc. 6

[H 124](#)

**“Can Finite Element Models Detect Clinically Inferior Cemented Hip Implants?”**

J. Stolk, Clinical Orthopaedics and Related Research, 409; 138-150, 2003

[H 126](#)

**LINK NEWS 16****Significance of the Lubinus SPII® hip prosthesis in the updated report of the Swedish National Total Hip Arthroplasty Register from 1979 through 2002**

Waldemar Link GmbH & Co. KG, 2004

[H 129](#)

**“Migration of cemented Stem and Restrictor after Total Hip Arthroplasty”**

F. Catani, A. Ensini, A. Leardini, L. Bragonzoni, The Journal of Arthroplasty, Vol. 20, No. 2 2005, pp. 244-249

[H 139](#)

**“Three hundred and twenty-one periprosthetic femoral fractures”**

H. Lindahl, G. Garellick, H. Malchau, Journal of Bone and Joint Surgery, Vol. 88-A, No. 6 2006

[H 147](#)

**“Socket wall addition device in the treatment of recurrent hip prosthesis dislocation ...”**

A.G. Enocson, J. Minde, O. Svensson, Acta Orthopaedica Scandinavica 2006; 77 (1): 87-91

[H 148](#)

**“Technik und Anwendungsmöglichkeiten der totalen Endoprothesen für das Hüftgelenk”**

H.W. Buchholz, Langenbecks Arch. f. Chir. 325 (1969) 777

**“Experimentelle Untersuchung zur Optimierung der Hüftendoprothese”**

E. Engelbrecht et al., Der Chirurg 51, 677-684 (1980), Springer-Verlag 1980

**“Klassifikation und Behandlungsrichtlinien von Knochensubstanzverlusten bei Revisiopsoperationen am Hüftgelenk - mittelfristige Ergebnisse.”**

E. Engelbrecht, K. Heinert, Primär- und Revisions-Alloarthroplastik Hüft- und Kniegelenk. Berlin, Heidelberg, New York usw., Springer 1985, S. 189-201

**“Operationstechnik bei Hüftprothesenwechsel.”**

E. Nieder, Symposium: Hüft- und Kniegelenksendoprothetik - aktueller Kenntnisstand, Zukunftsperspektiven. Orthopäd. Universitätsklinik Oskar-Helene-Heim Berlin, 27.-28. März 1992, Berlin

**“Risk factors for failure after treatment of a periprosthetic fracture of the femur”**

H Lindahl, H Malchau, A Odén, G Garellick, The Journal of Bone & Joint Surgery (Br) 2006; 88-B: 26-30

**“A modular cementless stem vs. cemented long-stem-prostheses in revision surgery of the hip”**

RJ Weiss, A Stark, J Kärrholm, Acta Orthopaedica 2011, 82 (2): 136-142

<b>SPII Model Lubinus Long Stem Prosthesis</b> (all types)
<b>General Indications</b>
Mobility-limiting diseases, fractures or defects of the hip joint or proximal femur which cannot be treated by conservative or osteosynthetic procedures
<b>Indications</b>
Revision surgeries
Exceptional primary hip replacement conditions requiring prolonged bony anchorage (e.g. oncological bone deficiencies, fracture)
<b>Contraindications</b>
Acute and chronic infections, local and systemic insofar as they compromise the successful implantation of a total or hemi hip prosthesis
Allergies to (implant) materials
Insufficient / inadequate bone mass- or quality which prevents a stable anchorage of the prosthesis.

**INFORMATION:**

These indications/contraindications refer to standard cases. The ultimate decision on whether or not an implant is suitable for a patient must be made by the surgeon based on his/her individual analysis and his/her experience.

**INFORMATION:**

SPII Model Lubinus Long Stem Prosthesis XL Neck can be combined with prostheses heads up to +4 mm additional neck length.

Please note the following regarding the use of our implants:

**1. Choosing the right implant is very important.**

The size and shape of the human bone determines the size and shape of the implant and also limits the load capacity. Implants are not designed to withstand unlimited physical stress. Demands should not exceed normal functional loads.

**2. Correct handling of the implant is very important.**

Under no circumstances should the shape of a finished implant be altered, as this shortens its life span. Our implants must not be combined with implants from other manufacturers. The instruments indicated in the Surgical Technique must be used to ensure safe implantation of the components.

**3. Implants must not be reused.**

Implants are supplied sterile and are intended for single use only. Used implants must not be used again.

**4. After-treatment is also very important.**

The patient must be informed of the limitations of the implant. The load capacity of an implant cannot compare with that of healthy bone!

**5. Unless otherwise indicated, implants are supplied in sterile packaging.**

Note the following conditions for storage of packaged implants:

- Avoid extreme or sudden changes in temperature.
- Sterile implants in their original, intact protective packaging may be stored in permanent buildings up until the "Use by" date indicated on the packaging.
- They must not be exposed to frost, dampness or direct sunlight, or mechanical damage.
- Implants may be stored in their original packaging for up to 5 years after the date of manufacture. The "Use by" date is indicated on the product label.
- Do not use an implant if the packaging is damaged.

**6. Traceability is important.**

Please use the documentation stickers provided to ensure traceability.

**7. Further information** on the material composition is available on request from the manufacturer.

**Follow the instructions for use!**

## Waldemar Link GmbH & Co. KG, Hamburg

All content in this catalog, including text, pictures and data, is protected by law. Every instance of use, whether in part or in whole and which is not permitted by law, is subject to our prior consent. In particular, this applies to the reproduction, editing, translation, publishing, saving, processing, or passing on of content stored in databases or other electronic media and systems, in any manner or form. The information in the catalogs is solely intended to describe the products and does not constitute a guarantee.

The Surgical Technique described has been written to the best of our knowledge and belief, but it does not relieve the surgeon of his/her responsibility to duly consider the particularities of each individual case.

Products shown in this document may not be available in your country. The product availability is subject to the approval and/or registration regulations of the respective country. Please contact Waldemar Link GmbH & Co. KG if you have questions about the availability of LINK products in your country.

Waldemar Link GmbH & Co. KG and/or other corporate affiliated entities own, use or have applied for the following trademarks in many jurisdictions: LINK, BiMobile, SP II, Modell Lubinus, E-Dur, EndoDur, T.O.P. II, BetaCup, CombiCup PF, CombiCup SC, CombiCup R, MobileLink, C.F.P., LCU, SP-CL, LCP, MIT-H, Endo-Model, Endo-Model SL, MP, MEGASYSTEM-C, GEMINI SL, SPAR-K, LCK, Link OptiStem, HX, TiCaP, X-LINKed, PorAg, LINK PorEx, BiPorEx, PorEx-Z, TrabecuLink, Tilastan, customLINK, RescueSleeve, Stactip, VACUCAST.

Other trademarks and trade names may be used in this document to refer to either the entities claiming the marks and/or names or their products and are the property of their respective owners.

