







# MobileLink

Acetabular Cup System – TrabecuLink

**CE 0482**

Explanation of Pictograms			
	Manufacturer		Article number
	Material number		Product meets the applicable requirements, which are regulated in the EU harmonization legislation for the affixing of the CE marking.

# MobileLink

## Acetabular Cup System – TrabecuLink

**02 Surgical Technique**

- 02 Preoperative Planning
- 03 Preparation and Implantation

**24 System Compatibility Overview**

- 24 System Compatibility Overview

**27 Implants**

- 27 Shells – TrabecuLink
- 27 Cancellous Bone Screws. Spare Polar Screw
- 28 Ceramic Inserts
- 29 E-Dur Inserts
- 30 X-LINKed UHMWPE Inserts
- 31 Shell/Insert Adapter (Face Changer)
- 32 Dual Mobility Inserts
- 33 Dual Mobility Liner

**34 Instruments**

- 34 MobileLink Acetabular Cup System, Basic Instruments for dia 42 - 72 mm
- 38 MobileLink Acetabular Cup System, Revision Instruments
- 39 MobileLink Acetabular Cup System, Instruments for dia 74 - 80 mm
- 40 MobileLink Acetabular Cup System, Instruments for Dual Mobility Inserts (Option 1, Option 2)
- 42 Instrument Sets for LINK Acetabular Reamers
- 44 Additional Instruments, Trial Heads
- 45 Additional Instruments

**46 Accessories**

- 46 X-ray Templates

Important Information

## Preoperative

It is important to plan the intervention preoperatively in order to select the correct implant type and size and its final intraosseous position based on the patient's individual anatomy. The surgeon should perform a careful evaluation of the patient's clinical condition and consider the level of physical activity before performing a hip replacement.

For optimal results, the surgery should be planned in advance using the appropriate Templates. The magnification factor of the X-rays must be compatible with the factor on the Templates. MobileLink X-ray Templates are available in standard 1.1:1.

The implant size must be chosen from adequate AP and ML X-rays with sufficient legibility. Each X-ray should be large enough for application of the whole Template. A second X-ray of the unaffected joint is often helpful. Inadequate preoperative planning can lead to improper selection of the implants and/or incorrect implant positioning.

In principle, a load-bearing, stable acetabular fossa and solid lateral osseous coverage is desirable. To achieve a press-fit with primary stability, the osseous circumference of the acetabulum must be well preserved.

The **inclination** of the acetabular component should not be significantly above or below 45°. The **anteversion** should not be significantly above or below 15°.

Placement outside of these boundaries will result in reduced range of motion and could subsequently lead to subluxation and/or dislocation of the joint.

### INFORMATION:

Preoperative planning provides an initial estimation of the final situation but cannot conclusively determine the most adequate size to be used. The ultimate decision can only be taken intraoperatively.

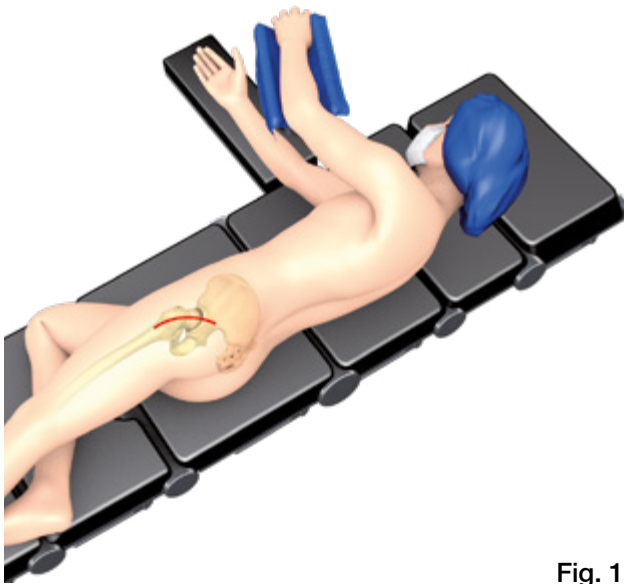
**MobileLink Acetabular Cup System****Fig. 1**

The MobileLink Acetabular Cup System can be implanted using any of the standard approaches for total hip replacement depending on the surgeon's experience (Fig 1).

**Acetabular Reaming****Fig. 2**

Depending on the approach used, the leg is positioned such that the acetabulum is well exposed.

The initial Reamer size corresponds to the width of the acetabular cup entrance. In normal anatomy the Reamer is inserted into the acetabulum at approximately 45° inclination and 15° anteversion (Fig. 2).

Consecutively Reamers with increasing diameters are applied until areas of bloody subchondral compact bone become visible but without compromising the supportive structure for secure anchoring of the Shell. It is essential to keep the Reamer head absolutely steady.

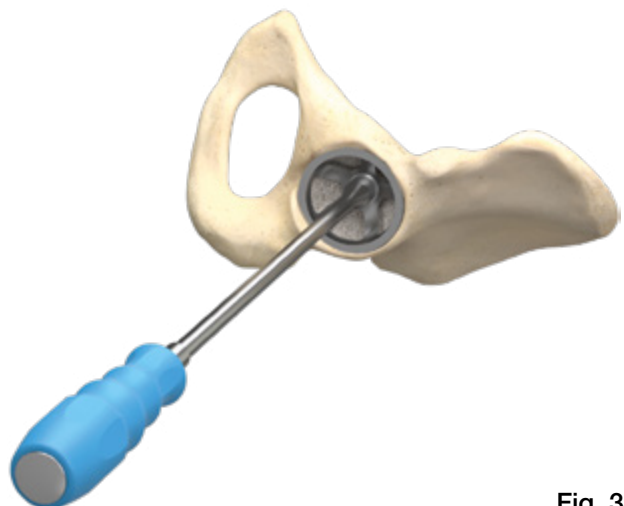
**Determination of Shell Size****Fig. 3**

Following preparation of the acetabulum, the Trial Cup is attached to the Universal Handle and is inserted into the acetabulum.

The Trial Cup is used to determine the size of the Shell as the Reamed cavity may be larger than originally intended. As soon as the Trial is firmly seated in the Reamed acetabulum the corresponding size of the Shell is to be selected (Fig. 3).

Compatibility Overview		
	Universal Handle	
	183-131/05	183-131/06
Driver Head	183-135/28 (Ø 28 mm), 183-135/32 (Ø 32 mm), 183-135/36 (Ø 36 mm), 183-135/40 (Ø 40 mm)	183-136/28, 183-136/32, 183-136/36, 183-136/40
Final Shell Impactor	183-135/10	183-136/10

**Table 1**

**Implantation of the Shell**



**Fig. 4**

**If Impactor Handle with Impactor Adapter (183-150/07 + 183-150/08) are used (Fig. 4):**

Screw the Impactor Adapter onto the Impactor Handle. Connect the Shell to the Impactor Handle. Attach the Alignment Guide.



**Fig. 5**

**If Monoblock Impactor Handle (183-150/09) is used (Fig. 5):**

Connect the Shell to the Impactor Handle. Attach the Alignment Guide.

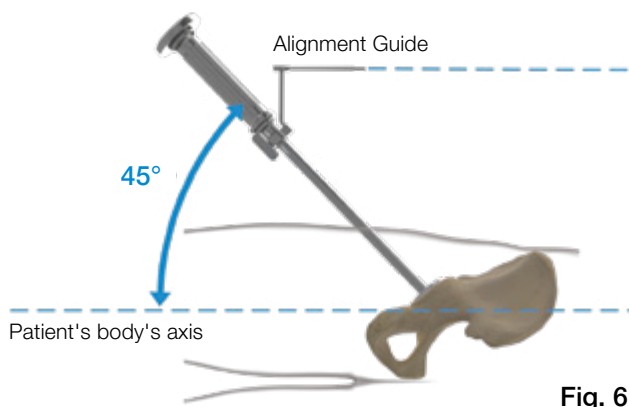

Fig. 6

In case the Offset Cup Impactor is used, see page 21 for a detailed description.

The Shell is aligned for 45° inclination using the corresponding Alignment Guide which is attached to the Impactor Handle. The Alignment Guide should be 90° to the body's axis. To achieve 15° anteversion the Impactor Handle is oriented such that the Alignment Rod is in parallel to the patient's body (Fig. 6 - 7).

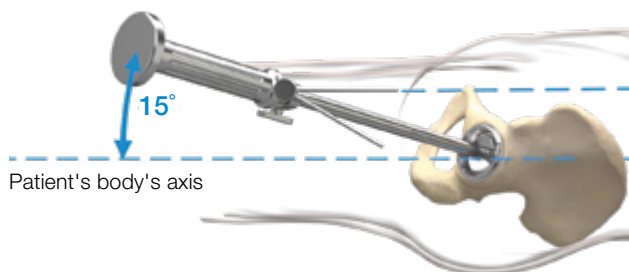

Fig. 7

Type of Shell	Shell size on label (mm)	Last Reamer used (mm)	Intraoperative press-fit (mm)
TrabecuLink	52	52	1.2
TrabecuLink	52	53	0.2

Table 2

The MobileLink Shells have a polar flattening of ~1 mm and have a built-in peripheral press-fit. The TrabecuLink Shells are designed with 1.2 mm. A Shell labelled with Shell size 52 mm for example has an actual size of 53.2 mm. The intraoperative press-fit depends on the last used Reamer as shown in Table 2.

**INFORMATION:**

Appropriate reaming should be based upon the patient's bone quality and determined by the surgeon intraoperatively.

The Shell is then driven with appropriate taps on the Impactor Handle into the prepared acetabulum.

**INFORMATION:**

The Impactor Handle must not be further tightened on the shell while impacting. The applied torque can lead to jamming of the Impactor Handle onto the Shell.

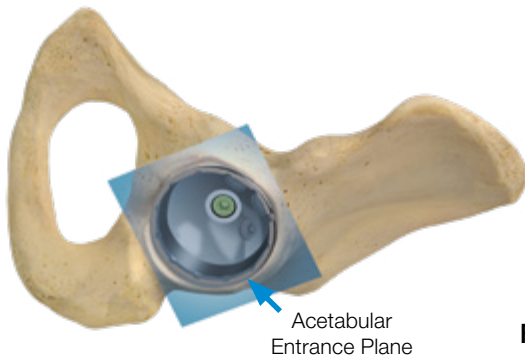

**Fig. 8**

The rim of the Shell should be parallel to the acetabulum entrance plane for secure seating in the surrounding bone (Fig. 8).

**INFORMATION:**

If it is noticed that the Shell is not fully seated, the optional Final Shell Impactor assembled with the Universal Handle may then be used instead of the Impactor Handle to assist in impacting the Shell in the dome area until it is completely seated in the prepared acetabulum.



**Fig. 9**

After impaction the polar hole is closed with the Polar Screw (only for Cluster hole Shell) (Fig. 9).

**CAUTION:**

The head of the Polar Screw should not protrude from the internal surface of the Shell, otherwise the Insert or Shell/Insert Adapter cannot be seated correctly.

**Optional:** Additional screw fixation (see page 10)

**Optional:** Shell/Insert Adapter (see page 11)



Shell size	Insert size
42/44 mm	A
46/48 mm	B
50/52 mm	C
54/56 mm	D
58/60 mm	E
62/64/66/68/70/72 mm	F
74/76/78/80 mm	G

Table 3

**Optional: Trial Reduction with Trial Insert**

The Trial Insert is chosen according to the Insert size, supported by a color coding, shown in Table 3.

The Trial Insert is placed in the Shell (Fig. 10).

In case components are used to correct inclination and/or offset, a Trial Insert is assembled with the corresponding Trial/Shell Insert Adapter. This assembly is placed in the Shell.

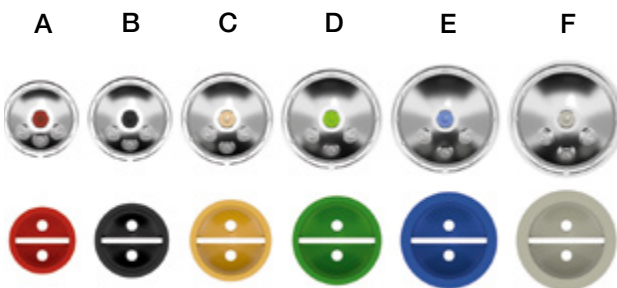

Cluster Hole Shells and Trial Inserts

**INFORMATION:**

Implant identification must be made according to laser marked information. Color coding is used only as a secondary reference. There may be slight variations in colors between components.



Fig. 10



Fig. 11

The reduction of the joint is performed with a Trial Head on the Femoral Rasp and Trial Neck.

After reduction of the joint, the leg length, joint stability and range of motion is checked (Fig. 11).

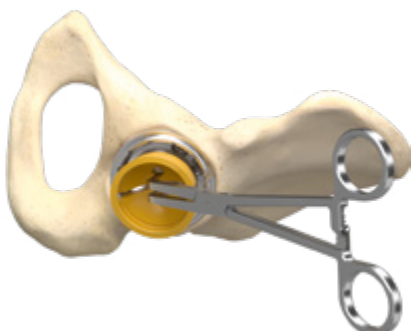

Fig. 12

The Trial Insert can be removed with the Forceps out of the Shell (Fig. 12).



Fig. 13

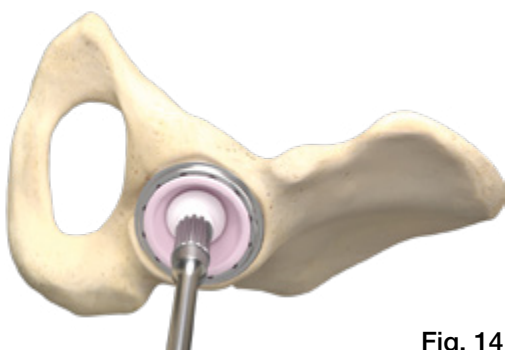

Fig. 14



Fig. 15



Fig. 16

### Implantation of the Ceramic Insert

#### CAUTION:

Do not repeatedly force the Ceramic Insert into place and do not use a Ceramic Insert in a Shell which prior has held a Ceramic Insert. In this case a UHMWPE Insert or a (Neutral) Shell/Insert Adapter must be used additionally.

Before the introduction of the Insert, the inside of the Shell is carefully cleaned and checked that surrounding soft tissues do not interfere with the introduction of the Insert.

For insertion the Insert Positioner can be used (Fig. 13).

Mount the Suction Pad on the Insert Positioner. Connect the Insert Positioner with the Universal Handle and mount the Ceramic Insert on the Suction Pad.

Place the Ceramic Insert in the Shell and push the Universal Handle gently into the Shell. Subsequently, the Insert is released from the Suction Pad by pulling the Universal Handle away from the Shell (Fig. 14).

#### CAUTION:

Do not hit on the Insert Positioner to fix the Insert in the Shell.

Assemble the Driver Head corresponding to the head size on the Universal Handle. Fix the Ceramic Insert with a light tap on the Driver Head assembly (Fig. 15).

Check the correct positioning of the Insert manually with circular motion at the Cup entrance. The rim of the Insert must not protrude at the entrance of the Shell (Fig. 16).

#### CAUTION:

Only Ceramic Inserts listed in this catalog are compatible. There is a high risk of ceramic insert fracture if other ceramic inserts are used.

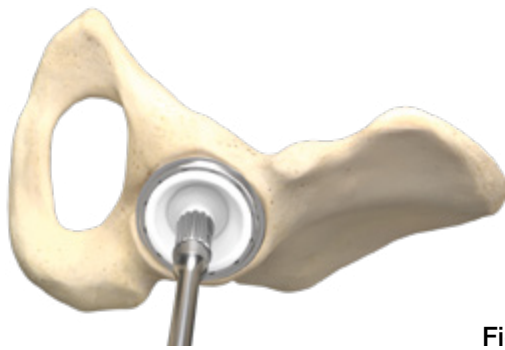

Fig. 17



Fig. 18



Fig. 19



Fig. 20

### Implantation of the UHMWPE Insert

Before the introduction of the Insert, the inside of the Shell is carefully cleaned and checked that surrounding soft tissues do not interfere with the introduction of the Insert.

UHMWPE Inserts can be introduced without the use of a Positioning Instrument. When introducing, the Insert is held between the thumb and index fingers.

The Insert is pressed into the Shell using the index finger, at which the pegs have to be correctly aligned with the recessed areas at the Shell.

Then the correct positioning of the Insert in the Shell is controlled.

The UHMWPE Inserts can also be positioned with the Insert Positioner as described in the prior section (Fig. 17).

To achieve a stable connection between the Insert and the Shell, the Insert is fixed in the same way as the Ceramic Insert described in the prior section (Fig. 18).

Check the correct positioning of the Insert manually with circular motion at the Cup entrance (Fig. 19).

#### CAUTION:

Range of motion is decreased for non-neutral UHMWPE Inserts

#### INFORMATION:

Neutral UHMWPE Inserts should be the preferred choice of insert.

### Final Reduction

With the final acetabular components in place, continue with the implantation of the femoral components.

Once all final implants are placed, perform the final reduction of the hip and check for joint stability and range of motion (Fig. 20).



Fig. 21

**Optional: Additional Screw Fixation**

The Shell may additionally be fixed with Cancellous Bone Screws. For that purpose the required number of Closing Screws has to be removed from the Cluster hole Shell (Fig. 21). The Multi Hole Shells are not delivered with Closing Screws.

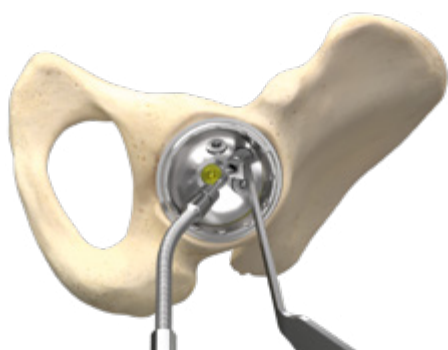

Fig. 22

A hole is drilled into the bone with the help of the Drill Guide, which is inserted into the hole in the desired direction with a maximum angulation of approximately +/-15° (Fig. 22).



Fig. 23

Use the Curved Depth Gauge to identify the correct length of the Cancellous Bone Screws (Fig. 23).



Fig. 24

To insert the Cancellous Bone Screws the Flexible or Rigid Screwdriver may be used (Fig. 24).

**CAUTION:**

The head of the Cancellous Bone Screws should not protrude from the internal surface of the Shell, otherwise the Insert or Shell/Insert Adapter cannot be seated correctly.

**CAUTION:**

Only Cancellous Bone Screws listed in this catalog are compatible.



Fig. 25



Fig. 26

**Optional: Shell/Insert Adapter (Face Changer)**

Different types of Shell/Insert Adapters can be used to restore the center of rotation and anteversion angle.

**Trial Adapters**

To choose the right type of Shell/Insert Adapter, the corresponding Trial Shell/Insert Adapter is placed in the Shell (Fig. 25). Consecutively a Trial Insert is chosen according to the Insert size shown in the table on page 31. The Trial Insert is placed in the Trial Shell/Insert Adapter (Fig. 26).

In case Neutral Shell/Insert Adapters are used, the trial reduction is performed with the standard Trial Inserts according to the Shell's insert size (consider Table 4)

Shell	Neutral Shell/Insert Adapter	Insert that fits into Adapter	Trial Insert to choose	Maximum Head size with Neutral Shell/Insert Adapter
50 - 52 mm	183-580/01	B	C	32 mm
54 - 56 mm	183-580/02	C	D	36 mm
58 - 60 mm	183-580/03	D	E	40 mm
62 - 72 mm	183-580/04	D	F	40 mm
74 - 80 mm	183-580/05	F	G	40 mm

Table 4



Fig. 27

After reduction of the joint, leg length, joint stability and range of motion is checked (Fig. 27).

The Trial Insert and Trial Shell/Insert Adapter can be removed with the Forceps.

**INFORMATION:**

We recommend that after the trial reduction the acetabulum should be marked at the level of the recess of the Trial Shell/Insert Adapter with a reference mark. This mark will help to align the final Shell/Insert Adapter.



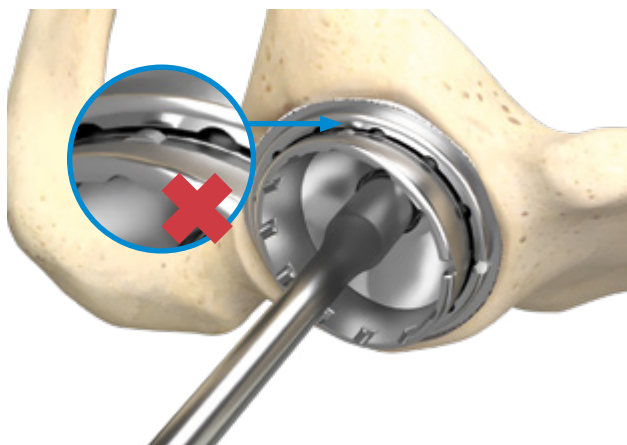

**Adapter Fixation**

Before the introduction of the Shell/Insert Adapter, the inside of the Shell must be cleaned carefully and checked that surrounding soft tissues do not interfere with the introduction.

The corresponding Shell/Insert Adapter is chosen according to the table on page 31.

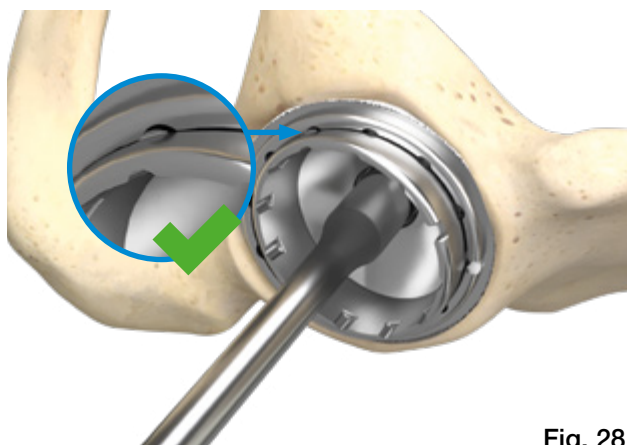
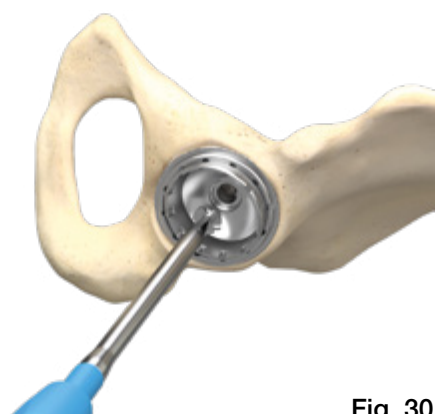

**Fig. 28**

The final Shell/Insert Adapter is placed in the Shell with the Shell/Insert Adapter Impactor and is fixed with an appropriate tap on the Shell/Insert Adapter Impactor (Fig. 28 - 29).



**Fig. 29**



**Fig. 30**

Offset and/or inclined Shell/Insert Adapters have to be fixed with the Shell/Insert Adapter Fixation Screw following impaction. This is done by first screwing the Shell/Insert Adapter Fixation Screw all the way in and tighten it gently (Fig. 30).



Fig. 31

The Fixation Screw is then finally tightened using the Torque Wrench (Fig. 31). Once the necessary torque is reached, the Torque Wrench will emit a loud snap.

**INFORMATION:**

The Torque Wrench must never be used to loosen screw connections, as this could have a negative effect on its function.



Fig. 32

After the insertion of the Shell/Insert Adapter, the step „Implantation of the Ceramic Insert“ or „Implantation of the UHMWPE Insert“ (Fig. 32) or the „Implantation of the Dual Mobility Insert“ follows.

**INFORMATION:**

Only Neutral and Shouldered UHMWPE Inserts are allowed to be used in conjunction with Shell/Insert Adapters.

**INFORMATION:**

Shell/Insert Adapter Fixation Screw must only be tightened once.

**Optional: Dual Mobility Insert**

The MobileLink Acetabular Cup System can be transformed into a dual mobility system with the Dual Mobility Insert.

**INFORMATION:**

The Dual Mobility Insert may be combined with the Shell or with the Shell/Insert Adapter (Face Changer), except for the neutral Shell/Insert Adapter (Face Changer).



Fig. 33

**Optional: Trial Reduction with Dual Mobility Trial Insert**

The Dual Mobility Trial Insert is chosen according to the Insert size, supported by a color coding. The Dual Mobility Trial Insert is placed in the Shell (Fig. 33) or in the Shell/Insert Adapter (Trial), except for the neutral Shell/Insert Adapter.

**INFORMATION:**

Implant identification must be made using laser marked information. Color coding is used only as a secondary reference. There may be slight variations in colors between components.

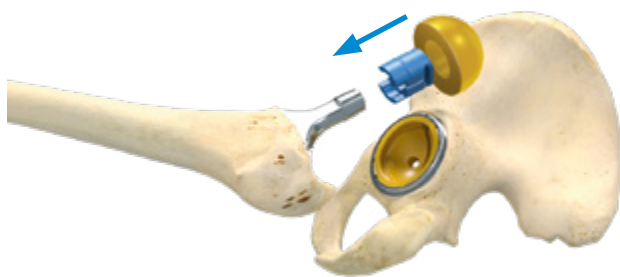

Fig. 34

**Option 1:**

Select the appropriate Plastic Trial Sleeve and seat it inside the Trial Liner for Trial Sleeves that corresponds to the implanted Dual Mobility Insert size which is also supported by a color coding (Fig. 34). The length of the Sleeve should correspond to the head neck length of the prosthesis head.



Fig. 35

Place the assembled Trial Liner and Sleeve onto the femoral rasp from the stem system or on the final femoral implant (Fig. 35).



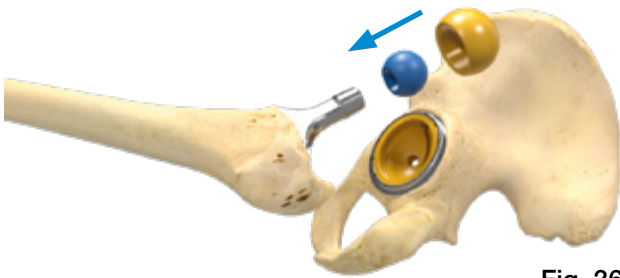

Fig. 36

**Option 2:**

Select the appropriate Plastic Trial Head and seat it inside the Trial Liner for Trial Heads that corresponds to the implanted Dual Mobility Insert size which is also supported by a color coding (Fig. 36).



Fig. 37

Place the assembled Trial Liner and Trial Head onto the femoral rasp from the stem system or on the final femoral implant (Fig. 37)



Fig. 38

After reduction of the joint, the leg length, joint stability and range of motion is checked (Fig. 38).



Fig. 39

The Trial Insert can be removed from the Shell with the Forceps (Fig. 39).

**INFORMATION:**

Prosthesis stems with classic taper and/or unfavourable neck design can reduce the range of motion.

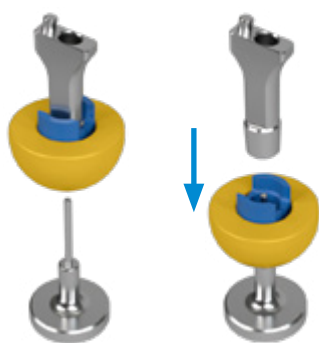

Fig. 40

**INFORMATION:**

In case the modular Trial Neck of the femoral implant system is stuck in the Plastic Trial Sleeve use the storage support of the Trial Heads/Trial Sleeves inside the instrument tray to loosen the Trial Neck as shown in Fig. 40.

**Dual Mobility Insert Fixation**

Before the introduction of the Dual Mobility Insert, the inside of the Shell or Shell/Insert Adapter must be cleaned carefully and checked that surrounding soft tissues do not interfere with the introduction.

Introduce the Dual Mobility Insert in the Shell or Shell/Insert Adapter. According to the approach used, orientate the shoulder of the Dual Mobility Insert in the desired position. The Insert is pressed into the Shell or Shell/Insert Adapter using the index finger. Then the correct positioning of the Insert in the Shell or Shell/Insert Adapter is controlled. Assemble the Final Shell Impactor on the Universal Handle. Fix the Dual Mobility Insert with a light tap on the Final Shell Impactor assembly (Fig. 41).

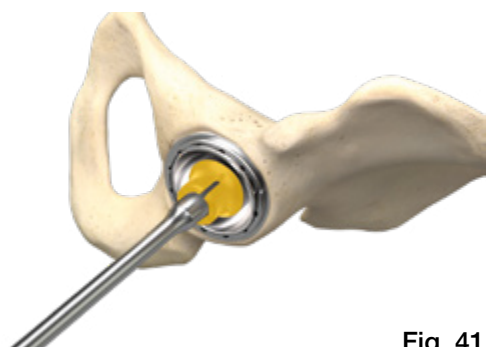

Fig. 41



Fig. 42

Check the correct positioning of the Dual Mobility Insert manually with circular motion at the Cup entrance. The rim of the Insert on the opposite side of the shoulder must not protrude at the entrance of the Shell (Fig. 42).

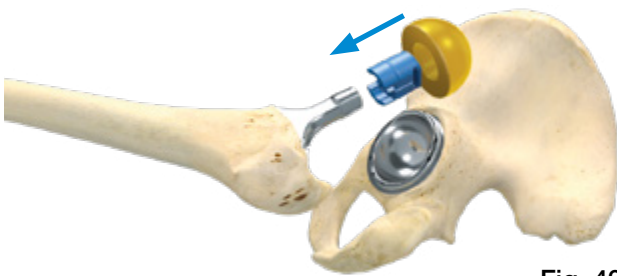

Fig. 43

### Trial Reduction with Dual Mobility Insert

#### Option 1:

Select the appropriate Plastic Trial Sleeve and seat it inside the Trial Liner for Trial Sleeve that corresponds to the implanted Dual Mobility Insert size (Fig. 43). The length of the Sleeve should correspond to the head neck length of the prosthesis head.

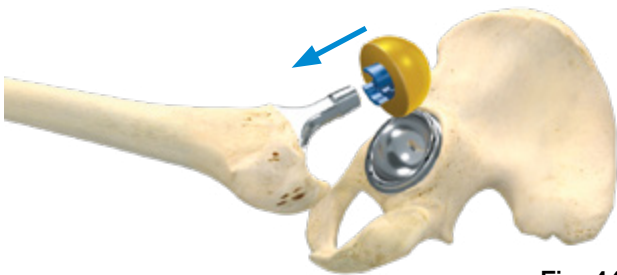

Fig. 44

Place the assembled Trial Liner and Sleeve onto the femoral rasp of the stem system or on the final femoral implant (Fig. 44).

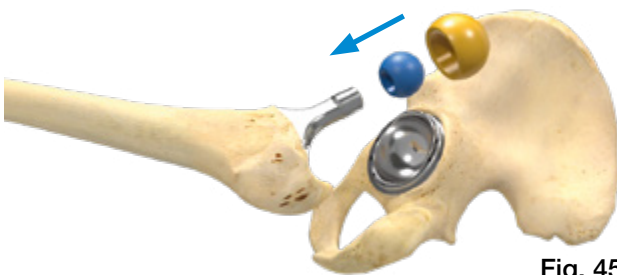

Fig. 45

#### Option 2:

Select the appropriate Plastic Trial Head and seat it inside the Trial Liner for Trial Heads that corresponds to the implanted Dual Mobility Insert size which is also supported by a color coding (Fig. 45).

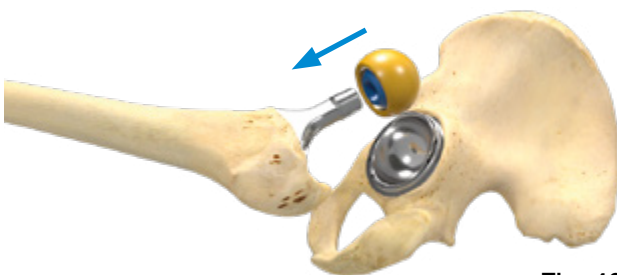

Fig. 46

Place the assembled Trial Liner and Trial Head onto the femoral rasp of the stem system or on the final femoral implant (Fig. 46).

#### INFORMATION:

The inner diameter of the Trial Liner is adjusted to Ø 28 mm. The final size of the Prosthesis Head may differ from the Plastic Trial Head. This does influence neither the range of motion nor the head neck length of the implant.



Fig. 47

After reduction of the joint, the leg length, joint stability and range of motion is checked (Fig. 47).

**INFORMATION:**

Prosthesis stems with classic taper and/or unfavourable neck design can reduce the range of motion.

**INFORMATION:**

In case the modular Trial Neck of the femoral implant system is stuck in the Plastic Trial Sleeve use the storage support of the Trial Heads/Trial Sleeves inside the instrument tray to loosen the Trial Neck as shown in Fig. 40.

**Assembly of Prosthesis Head and Liner**



Fig. 48

Place the Base of the Press on the instrumentation table.

Slide the Press into the Base (Fig. 48).



Fig. 49

Mount the Prosthesis Head Adapter Support onto the Press (Fig. 49).



Fig. 50

Place the Femoral Head on the Prosthesis Head Adapter Support (Fig. 50).

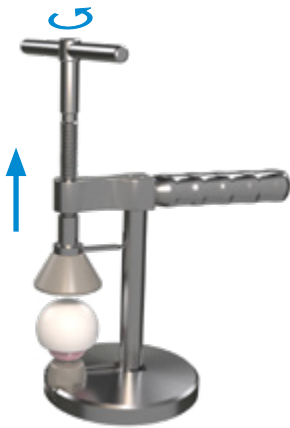

Fig. 51

Open the press completely by rotating the Press Handle counterclockwise. Position and place the Liner on the Head (Fig. 51).



Fig. 52

Rotate the Press Handle clockwise until the Liner is forced onto the Head (Fig. 52).

A distinctive “pop” sound should be heard.



Fig. 53

Once this sound is heard, rotate the Press Handle counterclockwise to open the Press (Fig. 53).

Check whether the Femoral Head rotates freely in the Liner. If the head does not rotate freely use the Press again.



Fig. 54

### Impaction of assembled Prosthesis Head and Liner

Place the assembled Prosthesis Head and Liner on the cleaned taper of the Femoral Stem and fix it with a light tap on the Head Impactor (Fig. 54).



Fig. 55a

### Final Reduction

Reduce the assembled Prosthesis Head and Liner into the cleaned Dual Mobility Insert with help of the Head Impactor (Fig. 55a)



Fig. 55b

and check the leg length, joint stability and range of motion (Fig. 55b).



Fig. 56

### Removal of the Shell

In case the Shell has to be revised, loosen the peripheral fixation by passing around the Shell with an osteotome (Fig. 56).

Open the polar hole by unscrewing the Polar Screw.

### If Impactor Handle with Impactor Adapter (183-150/07 + 183-150/08) are used:

Screw the Impactor Adapter onto the Impactor Handle. Connect the Shell to the Impactor Handle.

### If Monoblock Impactor Handle (183-150/09) is used :

Connect the Shell to the Impactor Handle.

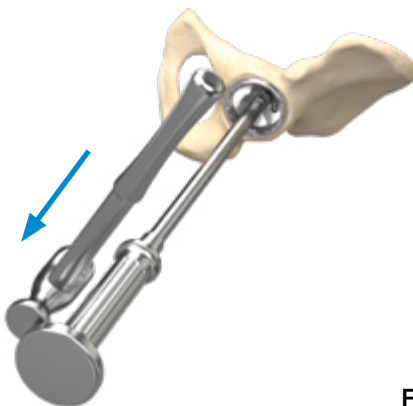

Fig. 57

Carefully pull the Shell out of the acetabulum with the help of gentle hammer taps from below on the impactor plate of the Impactor Handle (Fig. 57).

### Removal of a Ceramic Insert

The Ceramic Insert can be removed by placing the Extractor Handle for Ceramic Inserts on different positions on the edge of the Shell and appropriately tapping on the Extractor Handle (Fig. 58). The Insert will leap out due to the vibration.

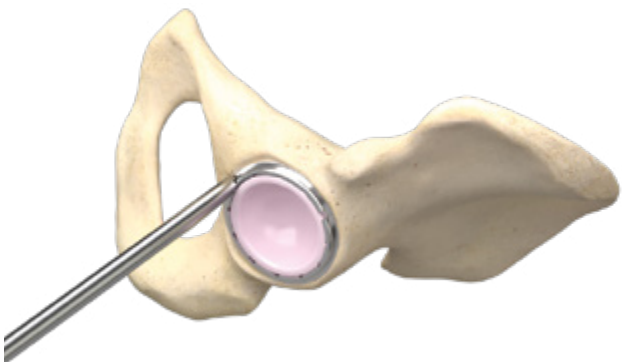

Fig. 58

### CAUTION:

For implantation of a new Ceramic Insert, please refer to page 08. The explanted Ceramic Insert must not be re-used.





Fig. 59

### Removal of a UHMWPE Insert

If removal of the Insert is necessary, pre-drill an off-center hole into the Insert (Fig. 59).

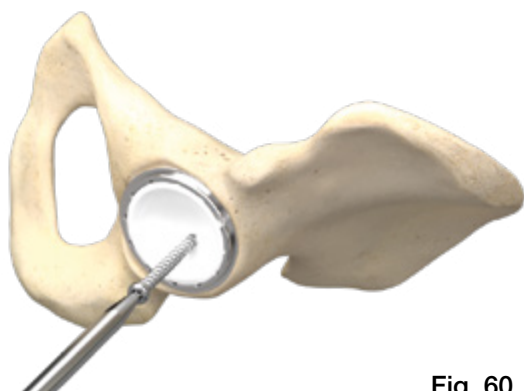

Fig. 60

Then a self-tapping Cancellous Bone Screw can be screwed into the pre-drilled hole to help remove the Polyethylene Insert (Fig. 60).



Fig. 61

### Removal of a Shell/Insert Adapter

Start with removal of the Insert as described above. Then unscrew the Shell/Insert Adapter Fixation Screw with the Rigid Screwdriver. After the Fixation Screw is removed, screw the Extractor Handle for Shell/Insert Adapter into the thread on the dome of the Shell/Insert Adapter and turn it clockwise until the Adapter is loosened (Fig. 61).

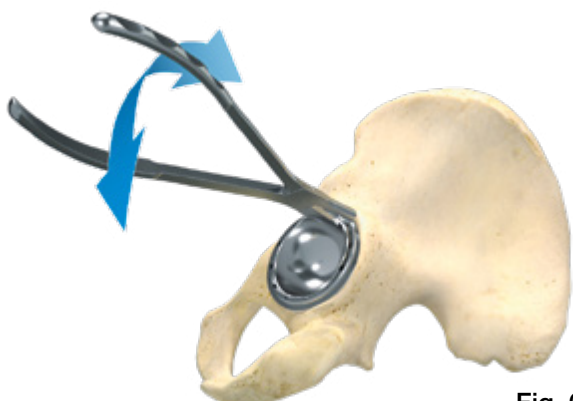
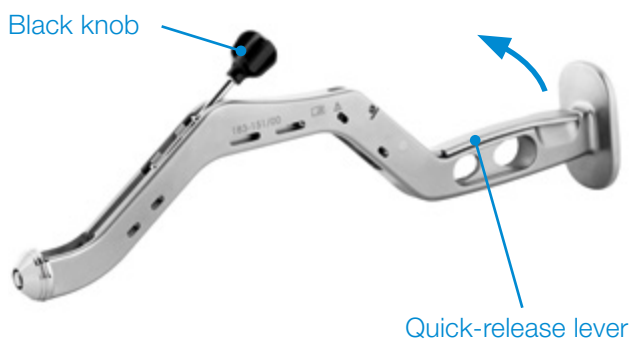

Fig. 62

### Removal of a Dual Mobility Insert

Place the Dual Mobility Insert Extractor Forceps under the shoulder of the Insert and lever it out of the Shell (Fig. 62).





**Offset Cup Impactor**

**Assembly**

**Step 1**

Open the quick-release lever.



**Step 2**

Position the Shell on the front of the Offset Cup Impactor while the quick-release lever is open. Mount the Shell on the Impactor by turning the black knob clockwise.

Once mounted, the Shell can be rotated and oriented with the knob.

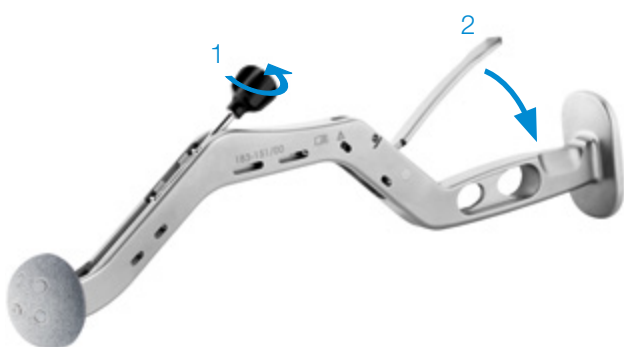

**Step 3**

Close the quick-release lever (2).

The Shell is fixed on the Impactor and can now be implanted.

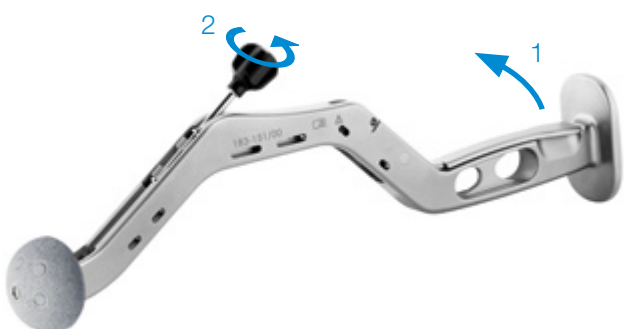

**Disassembly**

After impaction of the Shell, open the quick-release lever (1) and loosen the Impactor from the Shell by turning the knob counterclockwise (2).

## Shells



TrabecuLink  
Cluster Hole

## Shell/Insert Adapter (Face Changer)



neutral  
0 mm offset,  
0° inclination



+ 4 mm offset,  
0° inclination



+ 4 mm offset,  
+ 10° inclina-  
tion



+ 8 mm offset,  
+ 20° inclina-  
tion

## Fixation



Spare Shell/Insert Adapter  
Fixation Screw

## Inserts

Ceramic inserts



LINK CeraDur



BIOLOX delta\*

X-Linked

E-Dur



Standard



5 mm shoulder



Standard



5 mm shoulder

## Inserts

Ceramic inserts



LINK CeraDur



BIOLOX delta\*

X-Linked

E-Dur



Standard



5 mm shoulder



Standard



5 mm shoulder

Compatibility according to size

\* BIOLOX delta is made by CeramTec GmbH, Plochingen, Germany



TrabecuLink  
Multi Hole

Optional Fixation



Cancellous Bone Screws

Dual Mobility Insert



Shell/Insert Adapter (Face Changer)



+ 4 mm offset,  
0° inclination

+ 4 mm offset,  
+ 10° inclination

+ 8 mm offset,  
+ 20° inclination

Dual Mobility Liner



UHMWPE

E-DUR

Fixation



Spare Shell/Insert Adapter  
Fixation Screw

Dual Mobility Insert



Dual Mobility Liner



UHMWPE

E-DUR

## MobileLink Acetabular Cup System Compatibility

Group	A		B		C		D		E		F		
Shell Size	42	44	46	48	50	52	54	56	58	60	62-72		74-80
Insert Size	A		B		C		D		E		F		Only in conjunction with Shell/Insert Adapter for Shell size 74 - 80 mm

Combination Matrix of Shells and Inserts

Table 5

Group	A		B		C		D		E		F		G	
Shell Size	42	44	46	48	50	52	54	56	58	60	62-72		74-80	
Shell/Insert Adapter Size			Shell B	Insert A	Shell C	Insert B	Shell D	Insert C	Shell E	Insert D	Shell F	Insert D	Shell G	Insert F
Insert Size			A		B		C		D		D		F	

Combination Matrix of Shells and Shell/Insert Adapters

Table 6

Group	A		B		C		D		E		F		G	
Shell Size	42	44	46	48	50	52	54	56	58	60	62-72		74-80	
Dual Mobility Insert Size			B		C		D		E		F		G	
Dual Mobility Liner Size			B		C		D		E		F		G	

Combination Matrix of Shells, Dual Mobility Inserts and Dual Mobility Liner

Table 7

Group	A		B		C		D		E		F		G	
Shell Size	42	44	46	48	50	52	54	56	58	60	62-72		74-80	
Shell/Insert Adapter Size					Shell C	Insert B	Shell D	Insert C	Shell E	Insert D	Shell F	Insert D	Shell G	Insert F
Dual Mobility Insert Size					B		C		D		D		F	
Dual Mobility Liner Size					B		C		D		D		F	

Combination Matrix of Shell, Shell/Insert Adapter, Dual Mobility Insert und Dual Mobility Liner

Table 8

**Shells**

**MAT** *Ti*lotan -E (Ti6Al4V)



**TrabecuLink Shell, Cluster Hole**

incl. 1 Polar Screw for polar hole

**TrabecuLink Shell, Multi Hole**

Shells <b>REF</b>	Outer Ø mm	For Insert size	Shells <b>REF</b>	Outer Ø mm	For Insert size
183-201/42	42	<b>A</b>			
183-201/44	44				
183-201/46	46	<b>B</b>			
183-201/48	48				
183-201/50	50	<b>C</b>	183-401/50	50	<b>C</b>
183-201/52	52		183-401/52	52	
183-201/54	54	<b>D</b>	183-401/54	54	<b>D</b>
183-201/56	56		183-401/56	56	
183-201/58	58	<b>E</b>	183-401/58	58	<b>E</b>
183-201/60	60		183-401/60	60	
183-201/62	62	<b>F</b>	183-401/62	62	<b>F</b>
183-201/64	64		183-401/64	64	
183-201/66	66		183-401/66	66	
183-201/68	68		183-401/68	68	
183-201/70	70		183-401/70	70	
183-201/72	72		183-401/72	72	
			183-401/74*	74	Only in conjunction with Shell/Insert Adapter for Shell size 74 - 80 mm
			183-401/76*	76	
			183-401/78*	78	
			183-401/80*	80	

\* On request (lead time could increase)

**Cancellous Bone Screws for Shells**

**MAT** *Ti*lotan -S (Ti6Al4V)



<b>REF</b>	Ø × length mm	<b>REF</b>	Ø × length mm
180-658/15	6.5 × 15	180-658/45	6.5 × 45
180-658/20	6.5 × 20	180-658/50	6.5 × 50
180-658/25	6.5 × 25	180-658/55	6.5 × 55
180-658/30	6.5 × 30	180-658/60	6.5 × 60
180-658/35	6.5 × 35	180-658/70	6.5 × 70
180-658/40	6.5 × 40	180-658/80	6.5 × 80

**Spare Polar Screw for Shells**

**MAT** *Ti*lotan -S (Ti6Al4V)

<b>REF</b>
183-700/00



Inserts for MobileLink Acetabular Cup Components



**Ceramic inserts** (BIOLOX delta XLWzero)

**MAT** BIOLOX delta\* (ZTA Zirconoxid reinforced Aluminiumoxid Ceramic BIOLOX delta (Pink))



**Ceramic inserts**

**MAT** LINK CeraDur (ZTA Zirconoxid reinforced Aluminiumoxid Ceramic LINK CeraDur (White))

REF	Head Ø mm	Insert size
183-520/28	28	A
183-530/28	28	B
183-530/32	32	B
183-540/32	32	C
183-540/36	36	C
183-550/32	32	D
183-550/36	36	D
183-550/40	40	D
183-560/32	32	E
183-560/36	36	E
183-560/40	40	E
183-570/36	36	F
183-570/40	40	F

REF	Head Ø mm	Insert size
183-521/28	28	A
183-531/28	28	B
183-531/32	32	B
183-541/32	32	C
183-541/36	36	C
183-551/32	32	D
183-551/36	36	D
183-551/40	40	D
183-561/32	32	E
183-561/36	36	E
183-561/40	40	E
183-571/36	36	F
183-571/40	40	F

**INFORMATION:**

Ceramic Inserts out of BIOLOX delta\* must only be combined with Biolox Prostheses Heads.

Ceramic Inserts out of LINK CeraDur must only be combined with LINK CeraDur Prostheses Heads.

\* BIOLOX delta is made by CeramTec GmbH, Plochingen, Germany

Inserts for MobileLink Acetabular Cup Components

UHMWPE Inserts – **E-Dur**



**Standard (Neutral)**

**MAT** E-Dur (Vitamin E blended Highly Crosslinked UHMWPE)

**Anti-luxation**

**MAT** E-Dur (Vitamin E blended Highly Crosslinked UHMWPE),  
Shoulder height 5 mm

REF	Head Ø mm	Insert size
183-360/28	28	A
183-361/28	28	B
183-361/32	32	B
183-362/28	28	C
183-362/32	32	C
183-362/36	36	C
183-363/28	28	D
183-363/32	32	D
183-363/36	36	D
183-364/28	28	E
183-364/32	32	E
183-364/36	36	E
183-365/28	28	F
183-365/32	32	F
183-365/36	36	F
183-366/28	28	G
183-366/32	32	G
183-366/36	36	G

REF	Head Ø mm	Insert size
183-370/28	28	A
183-371/28	28	B
183-371/32	32	B
183-372/28	28	C
183-372/32	32	C
183-372/36	36	C
183-373/28	28	D
183-373/32	32	D
183-373/36	36	D
183-374/28	28	E
183-374/32	32	E
183-374/36	36	E
183-375/28	28	F
183-375/32	32	F
183-375/36	36	F
183-376/28	28	G
183-376/32	32	G
183-376/36	36	G

Inserts for MobileLink Acetabular Cup Components

UHMWPE Inserts – **X-LINKed**



**Standard (Neutral)**

**MAT** UHMWPE X-LINKed

**Anti-luxation**

**MAT** UHMWPE X-LINKed

Shoulder height 5 mm

REF	Head Ø mm	Insert size
183-350/28	28	A
183-351/28	28	B
183-351/32	32	B
183-352/28	28	C
183-352/32	32	C
183-352/36	36	C
183-353/28	28	D
183-353/32	32	D
183-353/36	36	D
183-354/28	28	E
183-354/32	32	E
183-354/36	36	E
183-355/28	28	F
183-355/32	32	F
183-355/36	36	F
183-356/28	28	G
183-356/32	32	G
183-356/36	36	G

REF	Head Ø mm	Insert size
183-740/28	28	A
183-741/28	28	B
183-741/32	32	B
183-742/28	28	C
183-742/32	32	C
183-742/36	36	C
183-743/28	28	D
183-743/32	32	D
183-743/36	36	D
183-744/28	28	E
183-744/32	32	E
183-744/36	36	E
183-745/28	28	F
183-745/32	32	F
183-745/36	36	F
183-746/28	28	G
183-746/32	32	G
183-746/36	36	G



**Shell/Insert Adapter (Face Changer)**

incl. Fixation Screw except for the Neutral (0 mm offset, 0° inclination) Shell/Insert Adapter

**MAT** *Ti/zotan* -S (Ti6Al4V)



neutral  
0 mm offset, 0° inclination

+ 4 mm offset,  
0° inclination

+ 4 mm offset,  
+ 10° inclination

+ 8 mm offset,  
+ 20° inclination

REF	For Shell size (Outer Ø)	Offset	Inclination	Insert that fits into Adapter
183-590/01*	46 - 48 mm	+ 4 mm	0°	A
183-600/06*		+ 4 mm	10°	
183-610/06*		+ 8 mm	20°	
183-580/01	50 - 52 mm	0 mm	0°	B
183-590/02		+ 4 mm	0°	
183-600/01		+ 4 mm	10°	
183-610/01		+ 8 mm	20°	
183-580/02	54 - 56 mm	0 mm	0°	C
183-590/03		+ 4 mm	0°	
183-600/02		+ 4 mm	10°	
183-610/02		+ 8 mm	20°	
183-580/03	58 - 60 mm	0 mm	0°	D
183-590/04		+ 4 mm	0°	
183-600/03		+ 4 mm	10°	
183-610/03		+ 8 mm	20°	
183-580/04	62 - 72 mm	0 mm	0°	D
183-590/05		+ 4 mm	0°	
183-600/04		+ 4 mm	10°	
183-610/04		+ 8 mm	20°	
183-580/05	74 - 80 mm	0 mm	0°	F
183-590/06		+ 4 mm	0°	
183-600/05		+ 4 mm	10°	
183-610/05		+ 12 mm	20°	

\* On request (lead time could increase)

**Spare Shell/Insert Adapter Fixation Screw**

**MAT** *Ti/zotan* -S (Ti6Al4V)

REF
183-710/00



**Dual Mobility Insert**

Polished inner surface

**MAT** CoCrMo



REF	Insert size
183-905/01	B
183-910/01	C
183-915/01	D
183-920/01	E
183-925/01	F
183-930/01	G

**Dual Mobility Liner**

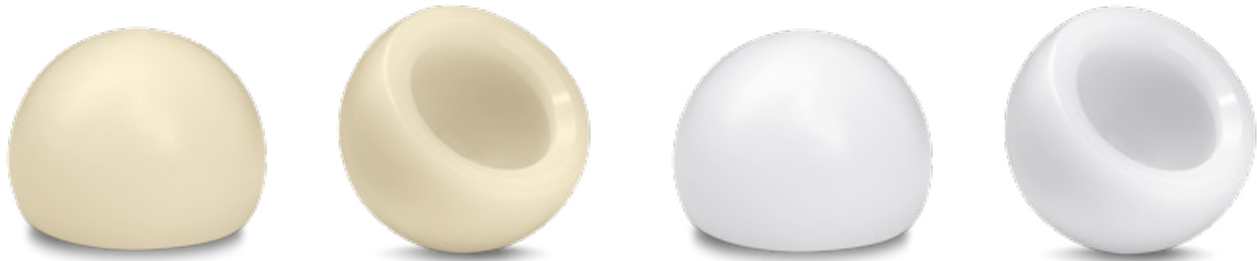

**Liner**

**MAT** E-Dur  
(Vitamin E blended Highly Crosslinked UHMWPE)

**Liner**

**MAT** UHMWPE

Liner <b>REF</b>	Inner Ø mm	Outer Ø mm	For Dual Mobility Insert size
184-270/02	22	36	<b>B</b>
184-280/01	28	40	<b>C</b>
184-280/03	28	44	<b>D</b>
184-280/05	28	48	<b>E</b>
184-280/06	28	50	<b>F</b>
184-280/12	28	62	<b>G</b>

Liner <b>REF</b>	Inner Ø mm	Outer Ø mm	For Dual Mobility Insert size
184-250/02	22	36	<b>B</b>
184-260/01	28	40	<b>C</b>
184-260/03	28	44	<b>D</b>
184-260/05	28	48	<b>E</b>
184-260/06	28	50	<b>F</b>
184-260/12	28	62	<b>G</b>

**INFORMATION:**

Note regarding the use of an Dual Mobility Insert: Extra long head necks with a skirt should not be used. This may decrease the Range of Motion and may cause an impingement risk with the Dual Mobility Liner.

183-110/01 MobileLink Acetabular Cup System, Basic Instruments

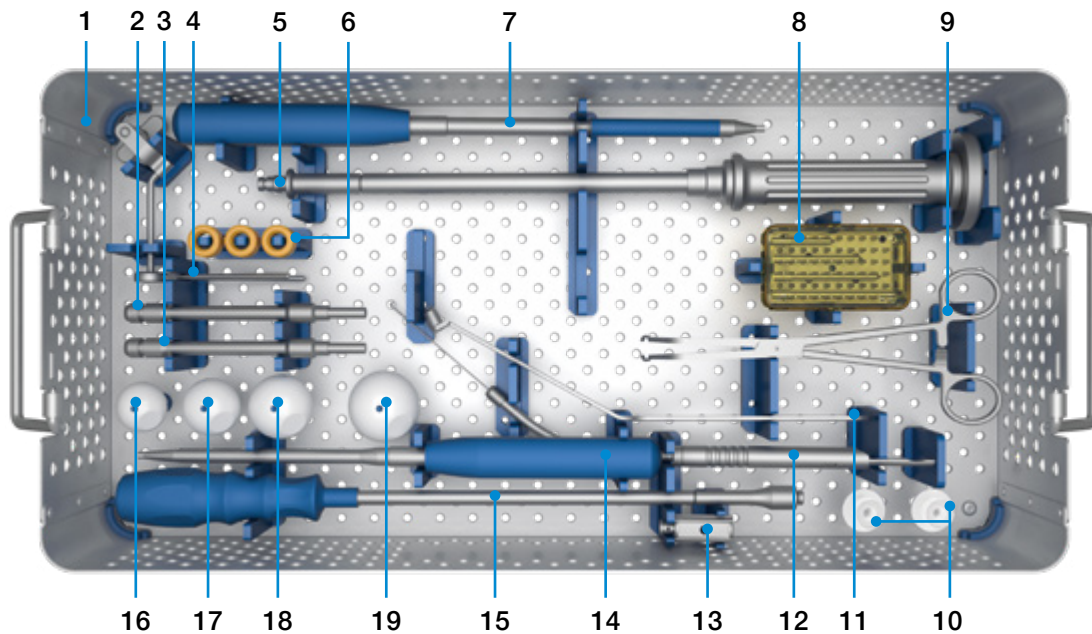

1	183-110/11	<b>Instrument Tray</b> , empty
2	15-8380/01 or 15-8380/01B or 15-8380/01D	<b>Drill Shaft</b> , flexible, 134 mm, Jacobs Chuck Fitting <b>Drill Shaft</b> , flexible, 134 mm, Hudson Fitting (B) <b>Drill Shaft</b> , flexible, 134 mm, AO Fitting (D)
3	15-8380/02 or 15-8380/02B or 15-8380/02D	<b>Drill Shaft</b> , rigid, 134 mm, Jacobs Chuck Fitting <b>Drill Shaft</b> , rigid, 134 mm, Hudson Fitting (B) <b>Drill Shaft</b> , rigid, 134 mm, AO Fitting (D)
4	183-150/04	<b>Alignment Guide</b> , for Impactor Handle <a href="#">183-150/07</a>
5	183-150/07* or 183-150/09* or 183-150/03*	<b>Impactor Handle</b> , straight, 406 mm, to be used with Impactor Adapter <a href="#">183-150/08</a> <b>Impactor Handle</b> , straight, monoblock, 406mm <b>Impactor Handle</b> , straight, 406 mm
6	183-150/08**	<b>Impactor Adapter</b> , yellow, 3 ×
7	15-8388/01	<b>Hex Screwdriver</b> , flexible, SW 3.5 mm, Ø 3.5 mm, self-holding screw
8	319-601/30 15-8381/02 15-8382/02 15-8383/02 15-8384/02	<b>Sterilizing Box</b> , contains: <b>Drill Cap</b> , 25 mm, Ø 3.2 mm <b>Drill Cap</b> , 40 mm, Ø 3.2 mm <b>Drill Cap</b> , 50 mm, Ø 3.2 mm <b>Drill Cap</b> , 60 mm, Ø 3.2 mm
9	15-8385/01	<b>Insertion Forceps</b> for screws
10	183-137/02	<b>Suction Pad</b> , 2 ×
11	183-138/32	<b>Drill Guide</b> , 3.6 mm
12	183-138/36	<b>Curved Depth Gauge</b>
13	183-137/01	<b>Insert Positioner</b>
14	15-8379/01	<b>Hex Screwdriver</b> , straight, SW 3.5 mm; self-holding screw

15	183-131/06* or 183-131/05*	Universal Handle Universal Handle
16	183-136/28* or 183-135/28*	Driver Head, Ø 28 mm Driver Head, Ø 28 mm
17	183-136/32* or 183-135/32*	Driver Head, Ø 32 mm Driver Head, Ø 32 mm
18	183-136/36* or 183-135/36*	Driver Head, Ø 36 mm Driver Head, Ø 36 mm
19	183-136/40* or 183-135/40*	Driver Head, Ø 40 mm Driver Head, Ø 40 mm

If Impactor Handle with Impactor Adapter is ordered separately, order number 183-150/10 may be chosen.  
183-150/10 includes: 183-150/07 + 3 × 183-150/08

\* For more information regarding compatibility see page 04

\*\* Only if 183-150/07 is used

Optional	
183-151/00	Offset Cup Impactor (see page 23 for detailed description)
183-136/10* or 183-135/10*	Final Shell Impactor Final Shell Impactor
15-8385/02	Drill Cap, 80 mm length, Ø 3.2 mm

183-110/01 MobileLink Acetabular Cup System, Basic Instruments

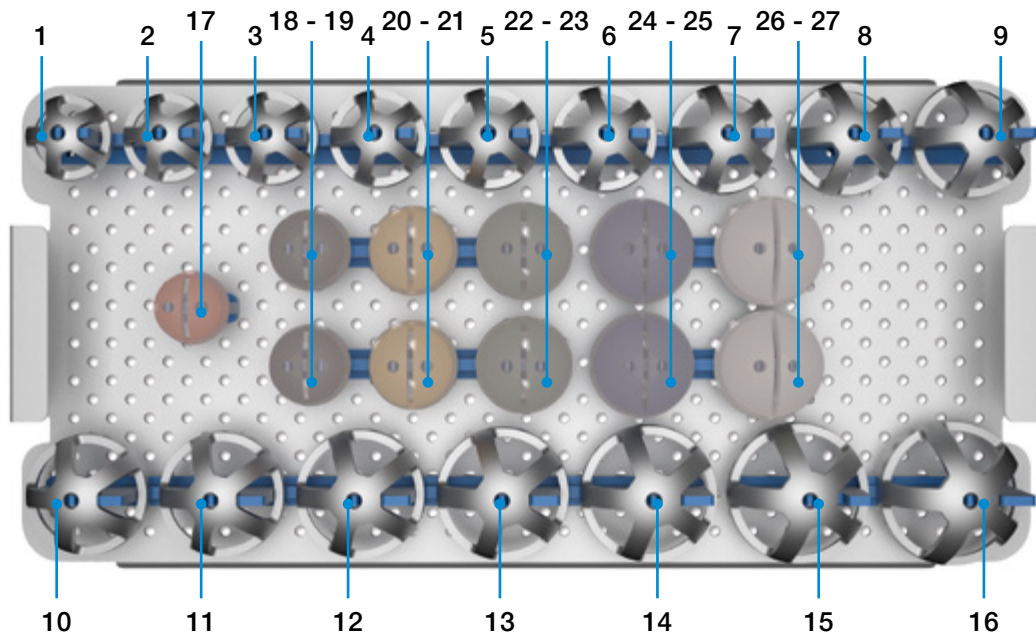

1	183-135/42	Trial Cup, Ø 42 mm
2	183-135/44	Trial Cup, Ø 44 mm
3	183-135/46	Trial Cup, Ø 46 mm
4	183-135/48	Trial Cup, Ø 48 mm
5	183-135/50	Trial Cup, Ø 50 mm
6	183-135/52	Trial Cup, Ø 52 mm
7	183-135/54	Trial Cup, Ø 54 mm
8	183-135/56	Trial Cup, Ø 56 mm
9	183-135/58	Trial Cup, Ø 58 mm
10	183-135/60	Trial Cup, Ø 60 mm
11	183-135/62	Trial Cup, Ø 62 mm
12	183-135/64	Trial Cup, Ø 64 mm
13	183-135/66	Trial Cup, Ø 66 mm
14	183-135/68	Trial Cup, Ø 68 mm
15	183-135/70	Trial Cup, Ø 70 mm
16	183-135/72	Trial Cup, Ø 72 mm

17	183-141/28*	<b>Trial Insert</b> , Head Ø 28 mm, Insert size A, red
18	183-142/28*	<b>Trial Insert</b> , Head Ø 28 mm, Insert size B, black
19	183-142/32*	<b>Trial Insert</b> , Head Ø 32 mm, Insert size B, black
20	183-143/28*	<b>Trial Insert</b> , Head Ø 28 mm, Insert size C, yellow
-	183-143/32*	<b>Trial Insert</b> , Head Ø 32 mm, Insert size C, yellow
21	183-143/36*	<b>Trial Insert</b> , Head Ø 36 mm, Insert size C, yellow
22	183-144/28*	<b>Trial Insert</b> , Head Ø 28 mm, Insert size D, green
-	183-144/32*	<b>Trial Insert</b> , Head Ø 32 mm, Insert size D, green
23	183-144/36*	<b>Trial Insert</b> , Head Ø 36 mm, Insert size D, green
	183-144/40*	<b>Trial Insert</b> , Head Ø 40 mm, Insert size D, green
24	183-145/28*	<b>Trial Insert</b> , Head Ø 28 mm, Insert size E, blue
-	183-145/32*	<b>Trial Insert</b> , Head Ø 32 mm, Insert size E, blue
25	183-145/36*	<b>Trial Insert</b> , Head Ø 36 mm, Insert size E, blue
	183-145/40*	<b>Trial Insert</b> , Head Ø 40 mm, Insert size E, blue
26	183-146/28*	<b>Trial Insert</b> , Head Ø 28 mm, Insert size F, grey
-	183-146/32*	<b>Trial Insert</b> , Head Ø 32 mm, Insert size F, grey
27	183-146/36*	<b>Trial Insert</b> , Head Ø 36 mm, Insert size F, grey
	183-146/40*	<b>Trial Insert</b> , Head Ø 40 mm, Insert size F, grey

\* On request (not included in set configuration 183-110/01)



183-110/02 MobileLink Acetabular Cup System, Revision Instruments

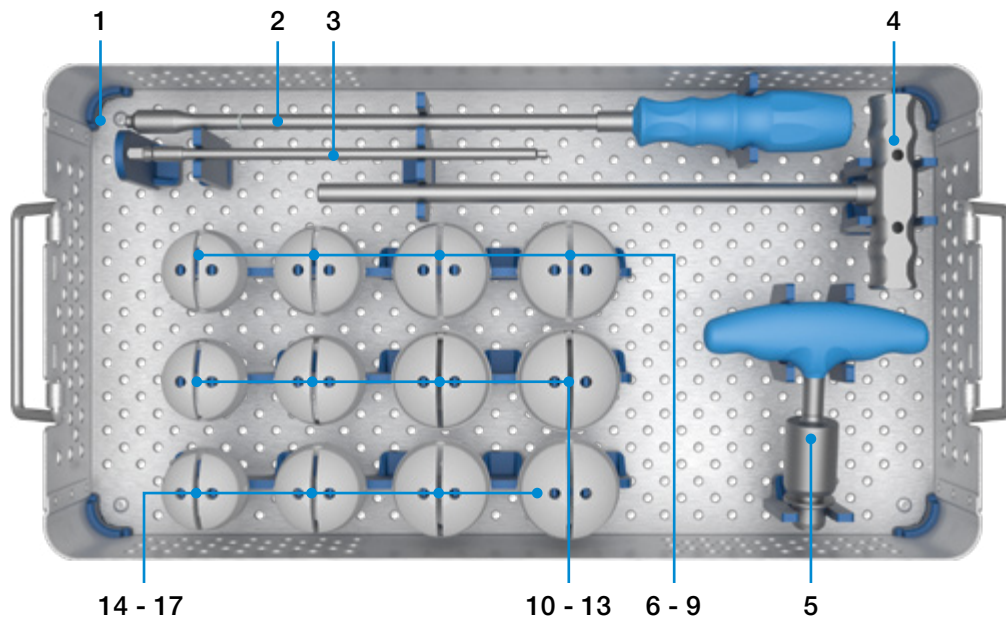

1	183-110/12	Instrument Tray, empty
2	183-168/01	Impactor for Shell/Insert Adapter
3	183-167/02	Torque Limiter Rod
4	183-169/02	Extractor for Shell/Insert Adapter
5	183-167/01	T-Handle with Torque Limiter
6	183-162/02	Trial Shell/Insert Adapter, + 4 mm offset, for Shell size 50 - 52 mm
7	183-162/03	Trial Shell/Insert Adapter, + 4 mm offset, for Shell size 54 - 56 mm
8	183-162/04	Trial Shell/Insert Adapter, + 4 mm offset, for Shell size 58 - 60 mm
9	183-162/05	Trial Shell/Insert Adapter, + 4 mm offset, for Shell size 62 - 72 mm
10	183-163/01	Trial Shell/Insert Adapter, + 4 mm offset, 10° inclination, for Shell size 50 - 52 mm
11	183-163/02	Trial Shell/Insert Adapter, + 4 mm offset, 10° inclination, for Shell size 54 - 56 mm
12	183-163/03	Trial Shell/Insert Adapter, + 4 mm offset, 10° inclination, for Shell size 58 - 60 mm
13	183-163/04	Trial Shell/Insert Adapter, + 4 mm offset, 10° inclination, for Shell size 62 - 72 mm
14	183-164/01	Trial Shell/Insert Adapter, + 8 mm offset, 20° inclination, for Shell size 50 - 52 mm
15	183-164/02	Trial Shell/Insert Adapter, + 8 mm offset, 20° inclination, for Shell size 54 - 56 mm
16	183-164/03	Trial Shell/Insert Adapter, + 8 mm offset, 20° inclination, for Shell size 58 - 60 mm
17	183-164/04	Trial Shell/Insert Adapter, + 8 mm offset, 20° inclination, for Shell size 62 - 72 mm

Optional		
183-169/01	Extractor for Ceramic Inserts	
183-162/01	Trial Shell/Insert Adapter, + 4 mm offset, for Shell size 46 - 48 mm	
183-163/06	Trial Shell/Insert Adapter, + 4 mm offset, 10° inclination, for Shell size 46 - 48 mm	
183-164/06	Trial Shell/Insert Adapter, + 8 mm offset, 20° inclination, for Shell size 46 - 48 mm	



183-110/03 MobileLink Acetabular Cup System, Instruments for 74 - 80 mm

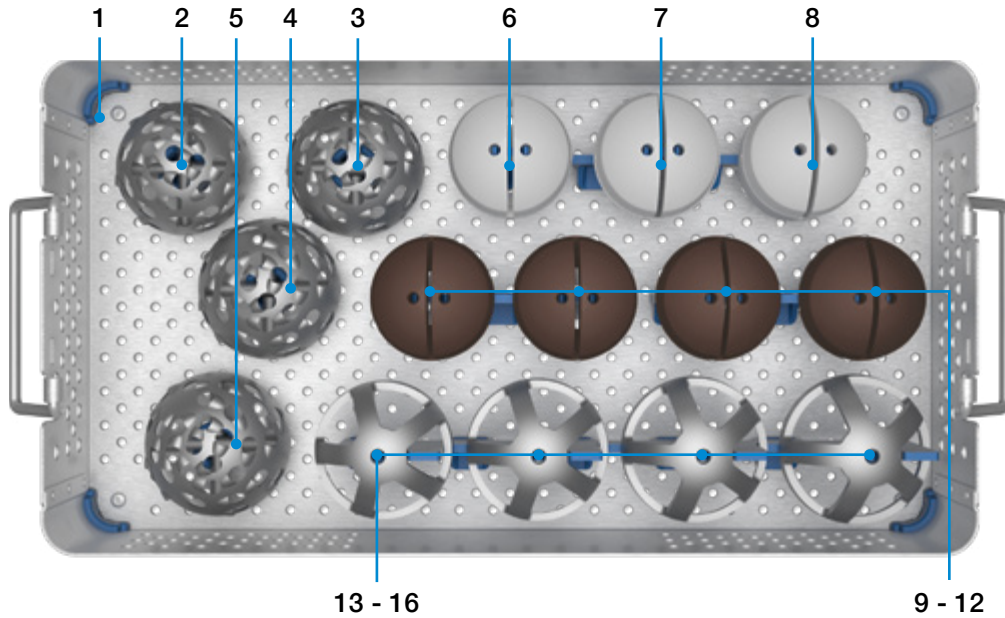

1	183-110/13	Instrument Tray, empty
2	131-170/74	Acetabular Reamer Head, Reamer-Ø 74 mm
3	131-170/76	Acetabular Reamer Head, Reamer-Ø 76 mm
4	131-170/78	Acetabular Reamer Head, Reamer-Ø 78 mm
5	131-170/80	Acetabular Reamer Head, Reamer-Ø 80 mm
6	183-162/06	Trial Shell/Insert Adapter, + 4 mm offset, for Shell size 74 - 80 mm
7	183-163/05	Trial Shell/Insert Adapter, + 4 mm offset, 10° inclination, for Shell size 74 - 80 mm
8	183-164/05	Trial Shell/Insert Adapter, + 12 mm offset, 20° inclination, for Shell size 74 - 80 mm
9	183-147/28	Trial Insert, Head Ø 28 mm, neutral, Insert size G, brown
10	183-147/32	Trial Insert, Head Ø 32 mm, neutral, Insert size G, brown
11	183-147/36	Trial Insert, Head Ø 36 mm, neutral, Insert size G, brown
12	183-147/40	Trial Insert, Head Ø 40 mm, neutral, Insert size G, brown
13	183-135/74	Trial Cup, Ø 74 mm
14	183-135/76	Trial Cup, Ø 76 mm
15	183-135/78	Trial Cup, Ø 78 mm
16	183-135/80	Trial Cup, Ø 80 mm

**183-960/01 MobileLink Acetabular Cup System,  
Instruments for Dual Mobility Inserts (Option 1)**

If Dual Mobility Insert is used, only one Option is necessary.

Choose Option 1 for unipolar trialing or Option 2 for bipolar trialing.

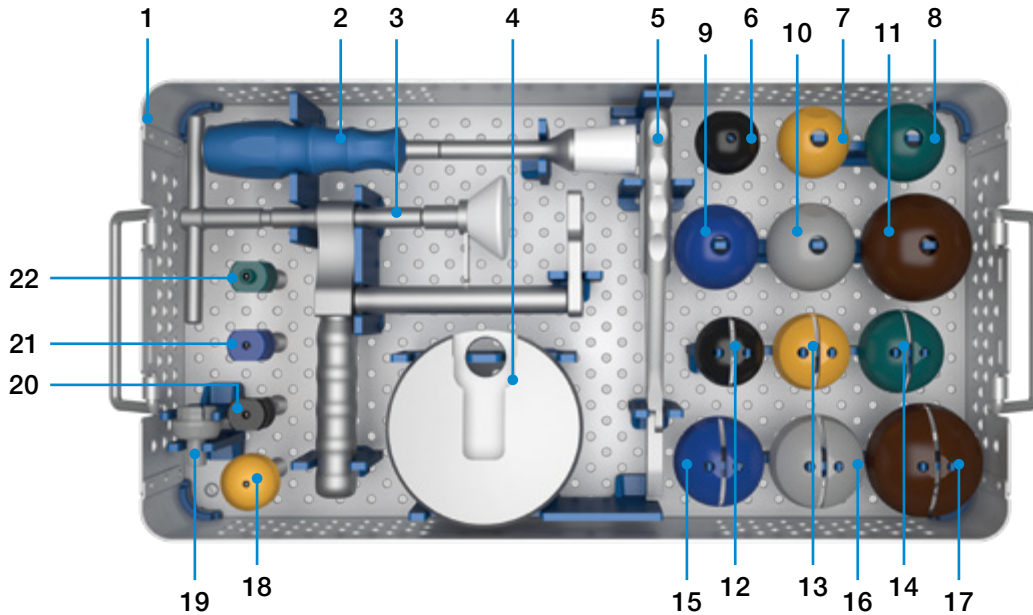

1	183-960/11	Instrument Tray, empty
2	175-360	Head Impactor
3	184-360/00	Press
4	184-361/00	Base
5	183-950/01	Extraction Forceps
6	184-320/44	Trial Liner for Trial Sleeve, size B, black
7	184-320/48	Trial Liner for Trial Sleeve, size C, yellow
8	184-320/52	Trial Liner for Trial Sleeve, size D, green
9	184-320/56	Trial Liner for Trial Sleeve, size E, blue
10	184-320/58	Trial Liner for Trial Sleeve, size F, grey
11	184-320/70	Trial Liner for Trial Sleeve, size G, brown
12	183-905/20	Dual Mobility Trial Insert, Insert size B
13	183-910/20	Dual Mobility Trial Insert, Insert size C
14	183-915/20	Dual Mobility Trial Insert, Insert size D
15	183-920/20	Dual Mobility Trial Insert, Insert size E
16	183-925/20	Dual Mobility Trial Insert, Insert size F
17	183-930/20	Dual Mobility Trial Insert, Insert size G
18	183-136/10* or 183-135/10*	Final Shell Impactor
19	184-362/00	Adapterbase for prosthesis head
20	106-020/03	Plastic Trial Sleeve, Neck length long, L, black
21	106-020/02	Plastic Trial Sleeve, Neck length medium, M, blue
22	106-020/01	Plastic Trial Sleeve, Neck length short, S, green

\* For more information regarding compatibility see page 04

**183-960/02 MobileLink Acetabular Cup System, Instruments for Dual Mobility Inserts (Option 2)**

If Dual Mobility Insert is used, only one Option is necessary.

Choose Option 1 for unipolar trialing or Option 2 for bipolar trialing.

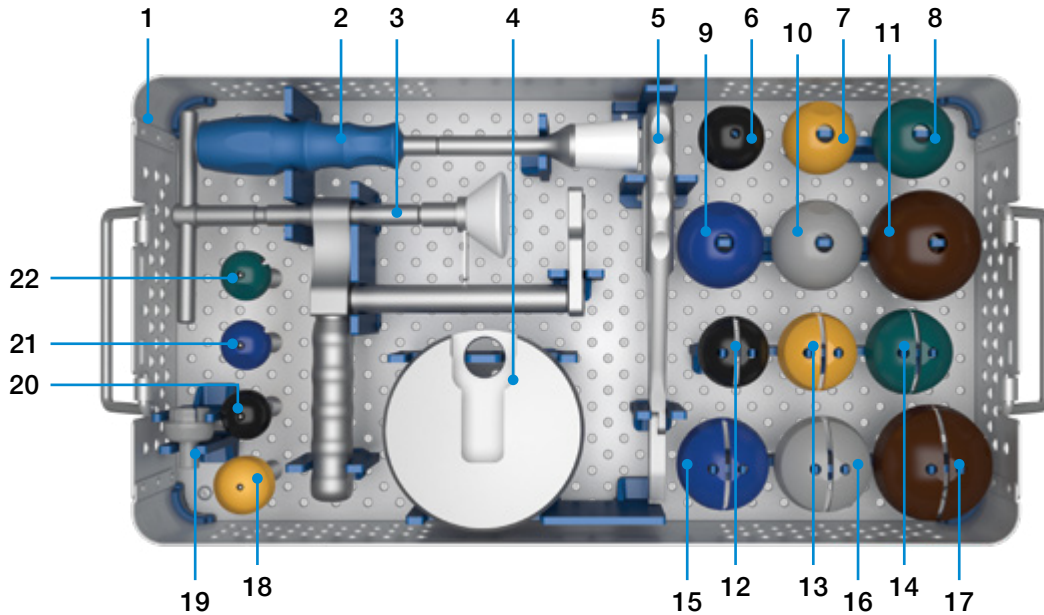

1	183-960/11	Instrument Tray, empty
2	175-360	Head Impactor
3	184-360/00	Press
4	184-361/00	Base
5	183-950/01	Extraction Forceps
6	184-321/44	Trial Liner,, for Ø 28mm Plastic Trial Heads, size B, black
7	184-321/48	Trial Liner, for Ø 28mm Plastic Trial Heads, size C, yellow
8	184-321/52	Trial Liner, for Ø 28mm Plastic Trial Heads, size D, green
9	184-321/56	Trial Liner, for Ø 28mm Plastic Trial Heads, size E, blue
10	184-321/58	Trial Liner, for Ø 28mm Plastic Trial Heads, size F, grey
11	184-321/70	Trial Liner, for Ø 28mm Plastic Trial Heads, size G, brown
12	183-905/20	Dual Mobility Trial Insert, Insert size B
13	183-910/20	Dual Mobility Trial Insert, Insert size C
14	183-915/20	Dual Mobility Trial Insert, Insert size D
15	183-920/20	Dual Mobility Trial Insert, Insert size E
16	183-925/20	Dual Mobility Trial Insert, Insert size F
17	183-930/20	Dual Mobility Trial Insert, Insert size G
18	183-136/10* or 183-135/10*	Final Shell Impactor
19	184-362/00	Adapterbase for prosthesis head
20	175-928/13	Plastic Trial Head, Ø 28 mm, Head neck length = + 3.5 mm, Neck length, L, black
21	175-928/12	Plastic Trial Head, Ø 28 mm, Head neck length = - 0 mm, Neck length, M, blue
22	175-928/11	Plastic Trial Head, Ø 28 mm, Head neck length = - 3.5 mm, Neck length, S, green

\* For more information regarding compatibility see page 04

Optional		
132-922/01	Plastic Trial Head, Ø 22 mm, Head neck length = - 3.5 mm, Neck length short, green	
132-922/02	Plastic Trial Head, Ø 22 mm, Head neck length = - 0 mm, Neck length medium, blue	
184-322/44	Trial Liner, for Ø 22 mm Plastic Trial Heads, size B, black	

132-260/01 Instrument Set for LINK Acetabular Reamers

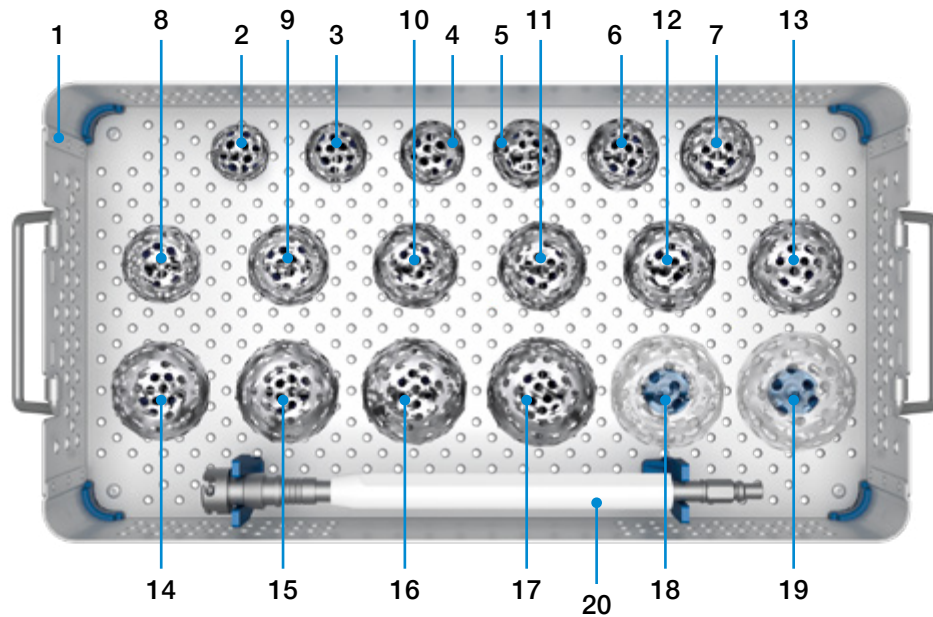

1	132-260/10	Instrument Tray, empty
2	131-170/38	Acetabular Reamer Head, Reamer-Ø 38 mm
3	131-170/40	Acetabular Reamer Head, Reamer-Ø 40 mm
4	131-170/42	Acetabular Reamer Head, Reamer-Ø 42 mm
5	131-170/44	Acetabular Reamer Head, Reamer-Ø 44 mm
6	131-170/46	Acetabular Reamer Head, Reamer-Ø 46 mm
7	131-170/48	Acetabular Reamer Head, Reamer-Ø 48 mm
8	131-170/50	Acetabular Reamer Head, Reamer-Ø 50 mm
9	131-170/52	Acetabular Reamer Head, Reamer-Ø 52 mm
10	131-170/54	Acetabular Reamer Head, Reamer-Ø 54 mm
11	131-170/56	Acetabular Reamer Head, Reamer-Ø 56 mm
12	131-170/58	Acetabular Reamer Head, Reamer-Ø 58 mm
13	131-170/60	Acetabular Reamer Head, Reamer-Ø 60 mm
14	131-170/62	Acetabular Reamer Head, Reamer-Ø 62 mm
15	131-170/64	Acetabular Reamer Head, Reamer-Ø 64 mm
16	131-170/66	Acetabular Reamer Head, Reamer-Ø 66 mm
17	131-170/68	Acetabular Reamer Head, Reamer-Ø 68 mm
18	131-170/70*	Acetabular Reamer Head, Reamer-Ø 70 mm
19	131-170/72*	Acetabular Reamer Head, Reamer-Ø 72 mm
20	131-171B**	Shaft with Handle for acetabular Reamer, 312 mm, fittings optional

\* On request (not included in set configuration 132-260/01)

\*\* How to order: 131-171E = with Jacobs Chuck fitting, spare part: 131-171/01 Handle for 131-171B, D or E

<b>B</b>	<b>D</b>	<b>E</b>
Hudson	AO	Jacobs Chuck



132-260/02 Instrument Set for LINK Acetabular Reamers

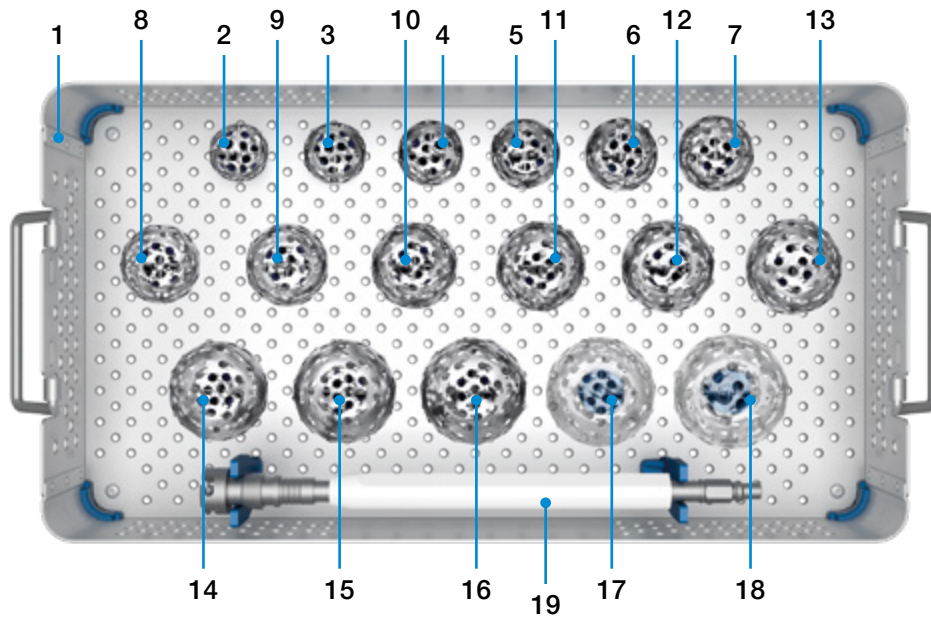

1	132-260/11	Instrument Tray, empty
2	131-170/41	Acetabular Reamer Head, Reamer-Ø 41 mm
3	131-170/43	Acetabular Reamer Head, Reamer-Ø 43 mm
4	131-170/45	Acetabular Reamer Head, Reamer-Ø 45 mm
5	131-170/47	Acetabular Reamer Head, Reamer-Ø 47 mm
6	131-170/49	Acetabular Reamer Head, Reamer-Ø 49 mm
7	131-170/51	Acetabular Reamer Head, Reamer-Ø 51 mm
8	131-170/53	Acetabular Reamer Head, Reamer-Ø 53 mm
9	131-170/55	Acetabular Reamer Head, Reamer-Ø 55 mm
10	131-170/57	Acetabular Reamer Head, Reamer-Ø 57 mm
11	131-170/59	Acetabular Reamer Head, Reamer-Ø 59 mm
12	131-170/61	Acetabular Reamer Head, Reamer-Ø 61 mm
13	131-170/63	Acetabular Reamer Head, Reamer-Ø 63 mm
14	131-170/65	Acetabular Reamer Head, Reamer-Ø 65 mm
15	131-170/67	Acetabular Reamer Head, Reamer-Ø 67 mm
16	131-170/69	Acetabular Reamer Head, Reamer-Ø 69 mm
17	131-170/71*	Acetabular Reamer Head, Reamer-Ø 71 mm
18	131-170/73*	Acetabular Reamer Head, Reamer-Ø 73 mm
19	131-171B**	Shaft with Handle for acetabular Reamer, 312 mm, fittings optional

\* On request (not included in set configuration 132-260/01)

\*\* How to order: 131-171E = with Jacobs Chuck fitting, spare part: 131-171/01 Handle for 131-171B, D or E

Optional	
131-170/75	Acetabular Reamer Head, Reamer-Ø 75 mm
131-170/77	Acetabular Reamer Head, Reamer-Ø 77 mm
131-170/79	Acetabular Reamer Head, Reamer-Ø 79 mm

183-110/06 Additional Instruments, Trial Heads

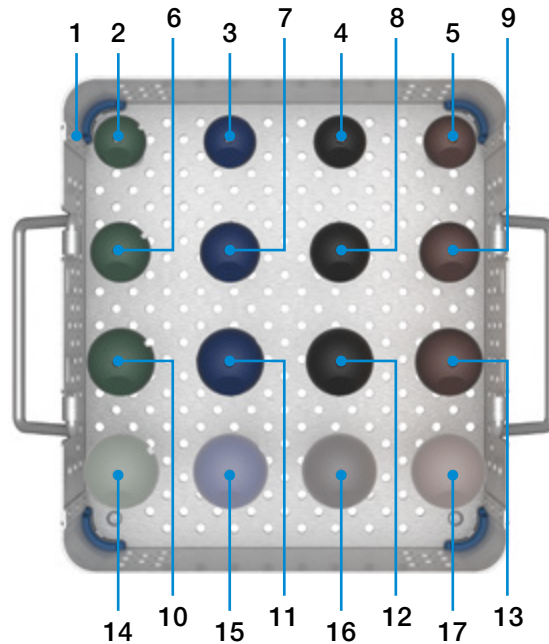

1	183-110/16	<b>Instrument Tray</b> , empty
2	175-928/11	<b>Trial Head</b> , PPSU, Taper 12/14, Ø 28 mm, Neck length short (-3.5 mm), green
3	175-928/12	<b>Trial Head</b> , PPSU, Taper 12/14, Ø 28 mm, Neck length medium (0.0 mm), blue
4	175-928/13	<b>Trial Head</b> , PPSU, Taper 12/14, Ø 28 mm, Neck length long (+3.5 mm), black
5	175-928/14	<b>Trial Head</b> , PPSU, Taper 12/14, Ø 28 mm, Neck length extra long (+10.5 mm), brown
6	175-932/11	<b>Trial Head</b> , PPSU, Taper 12/14, Ø 32 mm, Neck length short (-4.0 mm), green
7	175-932/12	<b>Trial Head</b> , PPSU, Taper 12/14, Ø 32 mm, Neck length medium (0.0 mm), blue
8	175-932/13	<b>Trial Head</b> , PPSU, Taper 12/14, Ø 32 mm, Neck length long (+4.0 mm), black
9	175-932/14	<b>Trial Head</b> , PPSU, Taper 12/14, Ø 32 mm, Neck length extra long (+8.5 mm), brown
10	175-936/11	<b>Trial Head</b> , PPSU, Taper 12/14, Ø 36 mm, Neck length short (-4.0 mm), green
11	175-936/12	<b>Trial Head</b> , PPSU, Taper 12/14, Ø 36 mm, Neck length medium (0.0 mm), blue
12	175-936/13	<b>Trial Head</b> , PPSU, Taper 12/14, Ø 36 mm, Neck length long (+4.0 mm), black
13	175-936/14	<b>Trial Head</b> , PPSU, Taper 12/14, Ø 36 mm, Neck length extra long (+8.0 mm), brown
14	175-940/11*	<b>Trial Head</b> , PPSU, Taper 12/14, Ø 40 mm, Neck length short (-4.0 mm), green
15	175-940/12*	<b>Trial Head</b> , PPSU, Taper 12/14, Ø 40 mm, Neck length medium (0.0 mm), blue
16	175-940/13*	<b>Trial Head</b> , PPSU, Taper 12/14, Ø 40 mm, Neck length long (+4.0 mm), black
17	175-940/14*	<b>Trial Head</b> , PPSU, Taper 12/14, Ø 40 mm, Neck length extra long (+8.0 mm), brown

\* On request (not included in set configuration 183-110/06)

Additional Instruments

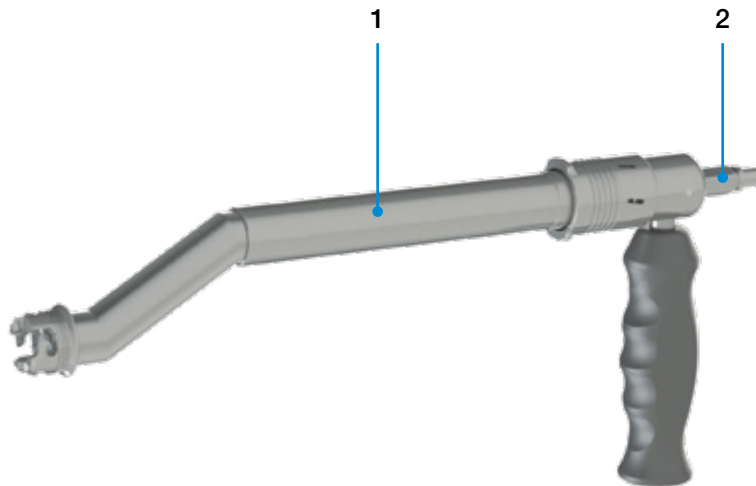

1	131-174/05	Offset Reamer Handle w/o Drive Shaft
	131-174/04B	Hudson Motor Shaft - Offset Reamer Handle (B)
2	131-174/04D	AO Motor Shaft - Offset Reamer Handle (D))
	131-174/04H	Stryker Z/H Motor Shaft - Offset Reamer Handle (H)

<p><b>B</b> Hudson</p>	<p><b>D</b> AO</p>	<p><b>H</b> Zimmer</p>
----------------------------	------------------------	----------------------------

**INFORMATION:**

Both, Offset Reamer Handle and Motor Shaft are required for the application of the Offset Reamer Handle.

**Accessories**

**X-ray Templates** for MobileLink Acetabular Cup System, 110% actual size

REF	X-ray Templates
183-170/01	<b>MobileLink X-ray Template</b> for Shell
183-170/02	<b>MobileLink X-ray Template</b> for Shell/Insert Adapter
183-170/03	<b>MobileLink X-ray Template</b> for Dual Mobility Insert

**Instructions for Cleaning and Maintenance**

Specific instructions for instruments are available on request from [info@link-ortho.com](mailto:info@link-ortho.com)



For more information please register for our LINK Media Library ([link-ortho.com](http://link-ortho.com))







**Please note the following regarding the use of our implants:**

**Follow the instructions for use!**

For detailed product information, including indications and contraindications, precautions and warnings, etc. please consult the product's Instructions for Use (IFU) prior to use.



[eifu.link-ortho.com](http://eifu.link-ortho.com)

**Waldemar Link GmbH & Co. KG, Hamburg, Germany**

All content in this catalog, including text, pictures and data, is protected by law. Every instance of use, whether in part or in whole or which is not permitted by law, is subject to our prior consent. This applies in particular to the reproduction, editing, translation, publishing, saving, processing, or passing on of content stored in databases or other electronic media and systems, in any manner or form. The information in the catalogs is solely intended to describe the products and does not constitute a guarantee.

The Surgical Technique described has been written to the best of our knowledge and belief, but it does not relieve the surgeon of their responsibility to duly consider the particularities of each individual case.

Products shown in this document may not be available in your country. The product availability is subject to the approval and/or registration regulations of the respective country. Please contact Waldemar Link GmbH & Co. KG if you have questions about the availability of LINK products in your country.

Waldemar Link GmbH & Co. KG and/or other corporate affiliated entities own, use or have applied for the following trademarks in many jurisdictions: LINK, BiMobile, SPII, Modell Lubinus, E-Dur, EndoDur, T.O.P. II, BetaCup, CombiCup PF, CombiCup SC, CombiCup R, MobileLink, C.F.P., LCU, SP-CL, LCP, MIT-H, Endo-Model, Endo-Model SL, MP, MEGASYSTEM-C, GEMINI SL, SPAR-K, LCK, HX, TiCaP, X-LINKed, PorAg, LINK PorEx, BiPorEx, PorEx-Z, TrabecuLink, Tilastan, customLink, RescueSleeve, VACUCAST.

Other trademarks and trade names may be used in this document to refer to either the entities claiming the marks and/or names or their products and are the property of their respective owners.

